

**LODZ UNIVERSITY OF TECHNOLOGY**  
Faculty of Electrical, Electronic,  
Computer and Control Engineering

**UNIVERSIDAD DE ALICANTE**  
University of Alicante Polytechnic School - EPSA

Bachelor of Engineering Thesis

**Design and optimization of telecommunication systems for a  
scattered group of 1 MW photovoltaic farms in Poland.**

**Projektowanie i optymalizacja systemów  
telekomunikacyjnych dla rozproszonej grupy farm  
fotowoltaicznych o mocy 1MW w Polsce.**

**Witold Bąk**

Student's number: 210873

Supervisor:  
**Prof. Andrzej Napieralski**

Auxiliary supervisors:  
**Enrique Tebar, PhD**  
**Zbigniew Kulesza, MSc**

Łódź, 2019

## **ACKNOWLEDGEMENT**

At the beginning of my paper I would like to thank Professor Ph.D. Andrzej Napieralski for permission to write an engineering thesis under his supervision and in his department. It is a great pleasure and honor for me.

Another thanks go to Dr Zbigniew Kulesza for his help and great knowledge. Thank you for his great support, invaluable tips in writing an engineering thesis and a good word, thank you for every meeting and time devoted. The help of you is invaluable.

Finally, I would like to thank Dr Enrique Tebar, a doctor from the University of Alicante, thanks to whom I was able to do an internship at the international company I+D Energias, which designs and builds photovoltaic farms. Thank you for training me in the company for several months. Thank to you and the entire international team, I was able to gain such extensive, theoretical and practical knowledge and invaluable skills necessary to build photovoltaic farms. It is a great pride and joy that I could work in your company.

Thank you all very much.

## **ABSTRACT**

After several months of work at I+D Energias, I learned about the construction process of photovoltaic farms in Poland from the perspective of an EPC (Engineering, Procurement and Construction) company. I had the opportunity to work with excellent people on various issues related to construction of the photovoltaic farm, mainly for communication needs. We have introduced optimization of farm monitoring & CCTV systems, which reduces costs and improves the quality of systems.

The purpose of the project was to detect and define existing problems in communication needs in a scattered group of 109 photovoltaic farms in Poland of 1 MW each (43 for Energija dossier and 66 for Lords dossier). We optimised monitoring and CCTV systems, we improved the solution for the gateway to the Internet, comparing Energija and Lords dossier, and we introduced a new solution for inverter's architecture for Lords dossier based on PLC technology, more convenient and compatible with Huawei inverters.

All the new solutions and specific technologies presented in this thesis made the construction process a photovoltaic farm in Poland cheaper and faster.

**KEYWORDS:** photovoltaic farms, monitoring system, optimisation, CCTV, gateway system

## STRESZCZENIE

Po kilku miesiącach pracy w I+D Energias poznałem proces budowy farm fotowoltaicznych w Polsce z perspektywy konstruowania, logistyki i budowy. Miałem okazję współpracować ze wspaniałymi ludźmi w różnych kwestiach związanych z budową farmy fotowoltaicznej, głównie w zakresie potrzeb komunikacyjnych. Wprowadziliśmy optymalizację systemów monitorowania i CCTV, co obniża koszty i wpływa na poprawę jakości systemów.

Celem projektu było rozpoznanie i zdefiniowanie problemów związanych z potrzebami komunikacyjnymi w rozproszonej grupie 109 farm fotowoltaicznych o mocy 1 MW w Polsce. Zoptymalizowaliśmy system monitorowania i CCTV, usprawniliśmy Gateway system w łączności Internetowej, porównując dokumentację projektów Energija i Lordów, wprowadzamy nowe rozwiązania dla architektury falowników. W dokumentacji projektów Lords stosujemy falowniki Huawei, co pozwala nam przebudować system architektury i zastosować wygodniejsze okablowanie PLC.

Wszystkie nowe rozwiązania i sprecyzowane technologie przedstawione w tej pracy inżynierskiej sprawiły, że proces budowy farmy fotowoltaicznej w Polsce jest tańszy i szybszy.

SŁOWA KLUCZOWE: farmy fotowoltaiczne, system monitoringu, optymalizacja, CCTV, gateway system

## Table of Contents

<b>1. INTRODUCTION</b> .....	7
1.1. Motivation.....	7
1.2. Thesis objective.....	8
1.3. Thesis architecture.....	8
1.4. General information.....	8
<b>2. INVERTERS PRODUCTION AND METEO MONITORING</b> .....	14
2.1. Inverters used: Sungrow vs Huawei architectures.....	14
2.2. Energija architecture: SCBs and Modbus connection.....	14
2.2.1. Student work for Energija architecture: SCBs and Modbus connection.....	17
2.2.2. Bulleted conclusions list for Energija architecture: SCBs and Modbus connection.....	24
2.3. Lords architecture: String Inverters and PLC connection.....	24
2.3.1. Student work for Lords architecture: String Inverters and PLC connection.....	25
2.3.2. Bulleted conclusions list for Lords architecture: String Inverters and PLC connection.....	32
2.4. Student analysis: Comparison between both architectures.....	33
2.5. Weather station.....	34
2.5.1. Student work for Weather Station: implementation and optimization of the system.....	35
2.5.2. Bulleted conclusions list for Weather Station: implementation and optimization of the system.....	39
2.6. SCADA software.....	40
2.6.1. Student work: Inverters productivity and weather conditions analysis by SCADA software.....	40
2.6.2. Bulleted conclusions list for Inverters productivity and weather conditions analysis by SCADA software.....	44
<b>3. CCTV SYSTEM</b> .....	45
3.1. CCTV Architecture.....	45
3.1.1. Student work for CCTV System Architecture: construction, optimization and run the system.....	46
3.1.2. Bulleted conclusions list for CCTV System Architecture: construction, optimization and run the system.....	53
3.2. Supervision and monitoring optimization by student in the EZStation software.....	54
3.3. Video analytics and FLIR System.....	57
3.3.1. Student work for Video analytics and FLIR System.....	58
3.3.2. Bulleted conclusions list for Video analytics and FLIR System.....	61
<b>4. GATEWAY TO THE INTERNET</b> .....	62
4.1. 4G Network in Poland.....	62

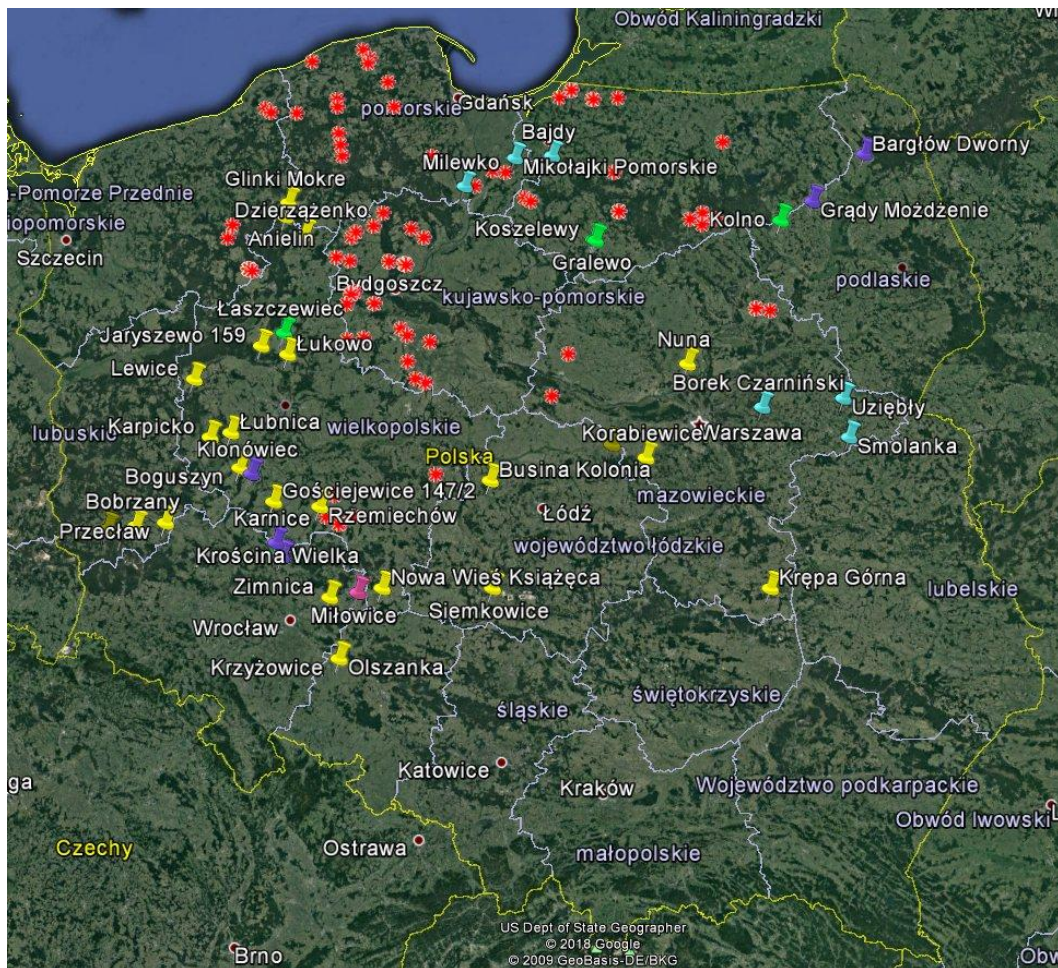
4.2.	Student work for Energija Dossier: Global Satellite Solution .....	63
4.2.1.	Bulleed conclusions list for Energija Dossier: Global Satellite Solution .....	66
4.3.	Student work for Lords Dossier: Migration to 4G .....	66
4.3.1.	Bulleed conclusions list for Lords Dossier: Migration to 4G .....	68
4.4.	Comparison of costs and speed rates and student observations .....	69
4.5.	Conclusion for Gateway to the Internet.....	70
<b>5.</b>	<b>CONCLUSIONS</b> .....	<b>72</b>
<b>6.</b>	<b>BIBLIOGRAPHY</b> .....	<b>76</b>
<b>7.</b>	<b>IMAGES LIST</b> .....	<b>77</b>
<b>8.</b>	<b>ANNEX 1: Monitoring Box Datasheets</b> .....	<b>79</b>
<b>9.</b>	<b>ANNEX 2: Meteo Box Datasheets</b> .....	<b>80</b>
<b>10.</b>	<b>ANNEX 3: Authors of the paper</b> .....	<b>81</b>

# 1.INTRODUCTION

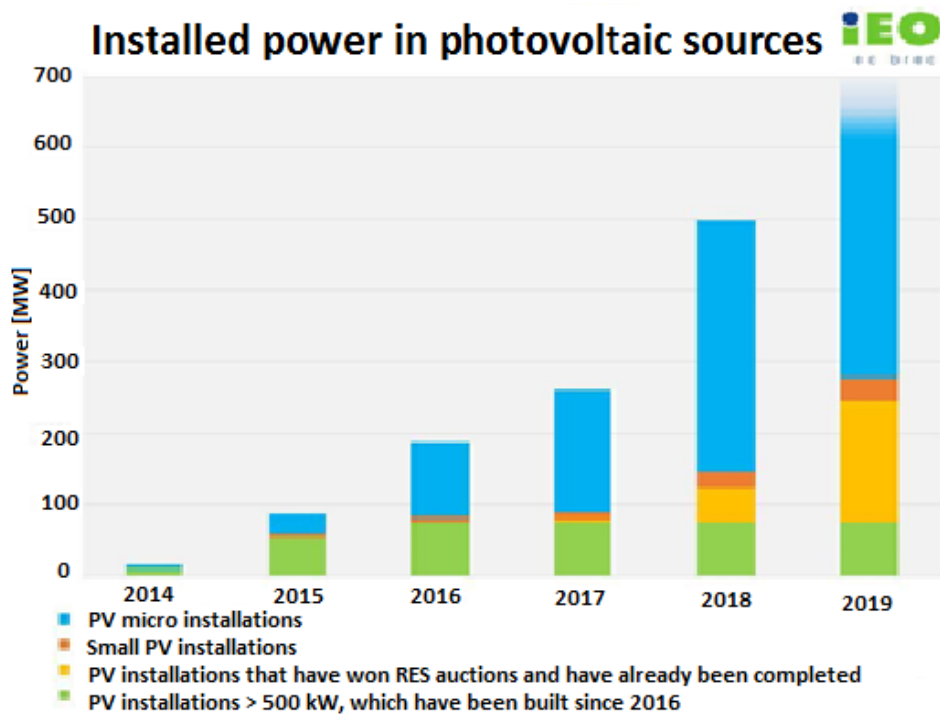
## 1.1. Motivation

The Engineering Thesis was prepared after the author's apprenticeship in one of the largest and rapidly operating companies in Solar Photovoltaics in Poland: The Spanish company I+D Energías, [1] which in cooperation with its Polish partner company Sun Investment Group (SIG) [2] is building a huge portfolio of 109 solar power plants, divided into 2 portfolios of 43 and 66 MW respectively, for 2 different clients. The first one for E Energija Group (locations marked in yellow at Image 1), was finished in June 2019 [3] and the second one for Lords LB Asset Management (locations marked in red), still under construction at September 2019. [4]

Nowadays, the demand for solar photovoltaic energy in Poland is growing very fast year-by-year, passing from less than 20 MW installed in 2014 up to 500 MW in 2018, as shown in the Image 2. [5]



**Image 1: Map of Poland with solar farms built by I+D Energías for Energija (in yellow) and Lords (in red). [company source]**



*Image 2: Graph of installed power in photovoltaic sources. [5]*

## 1.2. Thesis objective

In parallel with the development of PV farms, the demand for all services related to PV farm communication needs is increasing. The scope of works is the monitoring of the solar farms, CCTV systems, production control, atmospheric changes (through the weather station that is also installed to monitor weather parameters), security systems and an appropriate gateway to the Internet, by using specialized software and checking the quality of the network to improve the quality of systems operation.

Therefore, the objective to elaborate this thesis is to define and optimize the problems associated with the communication needs for the aforementioned scattered group of 1 MW photovoltaic farms in Poland.

## 1.3. Thesis architecture

This thesis consists of 5 chapters: First of them is an introduction with general information about PV farms in Poland. 2<sup>nd</sup> chapter deals with inverter monitoring and production control of solar farms, including weather station parameters, 3<sup>rd</sup> is about CCTV systems and 4<sup>th</sup> explains the 2 gateway systems used (Ka satellite and 4G network). Conclusions, in 5<sup>th</sup> and last chapter end this thesis.

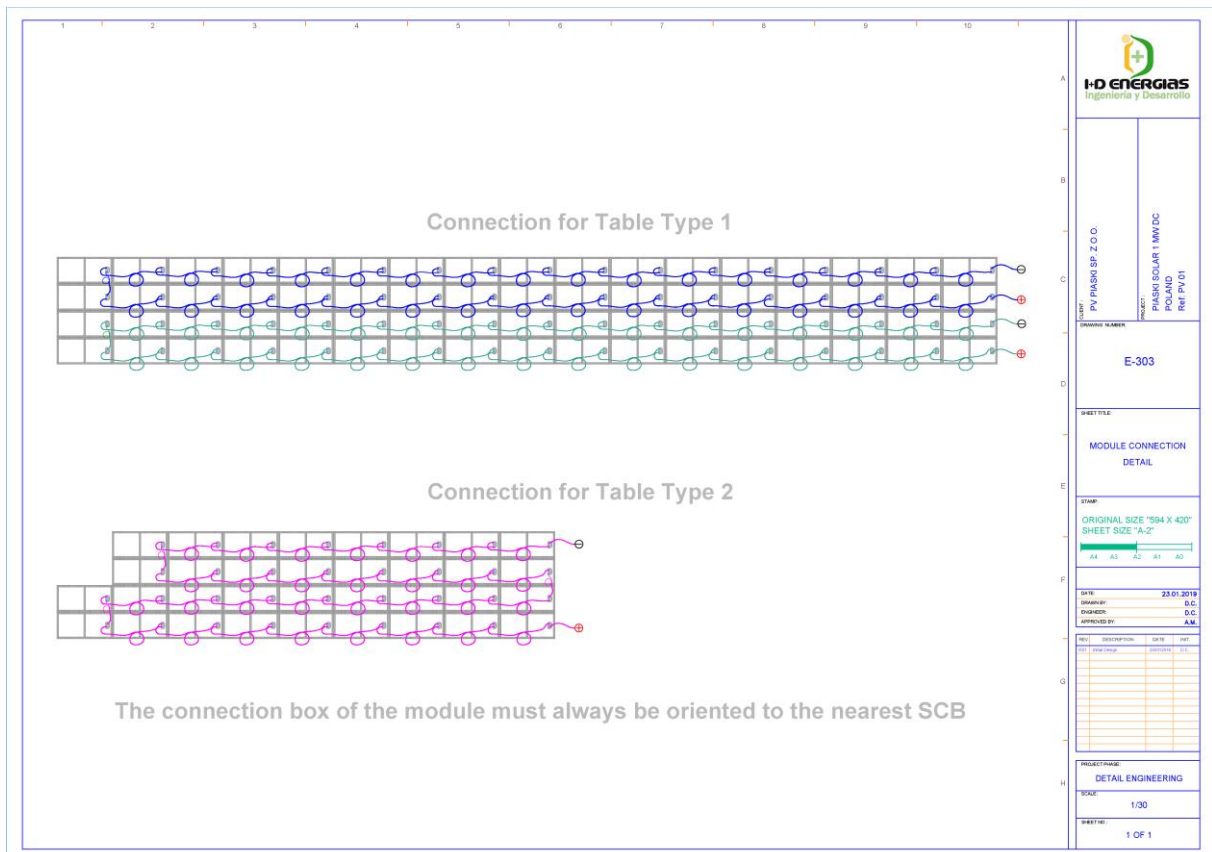
## 1.4. General information

The structure tables in the PV farm, where solar panels are set, follow a horizontal model “4H”, this means that 4 horizontal rows form every structural unit. The number of panels per



row can be 17 for big-size tables (“Type 1”, 4Hx17, 2 strings) or 9 for small-size tables (“Type 2”, 4Hx9, 1 string), as shown in Image 3.

Therefore, big-size tables are composed of 4Hx17 panels; 68 in total, 2 strings of 34 panels each, where every string is divided into 2 rows making a “C” connection to avoid the loop-closing cable. Concerning small-size tables, they are composed of 4Hx9 panels; 34 in total, just 1 string with 2 gaps (panel-free position), divided into 4 rows making a “zig-zag” connection, also to avoid the loop-closing cable as shown at Image 3.

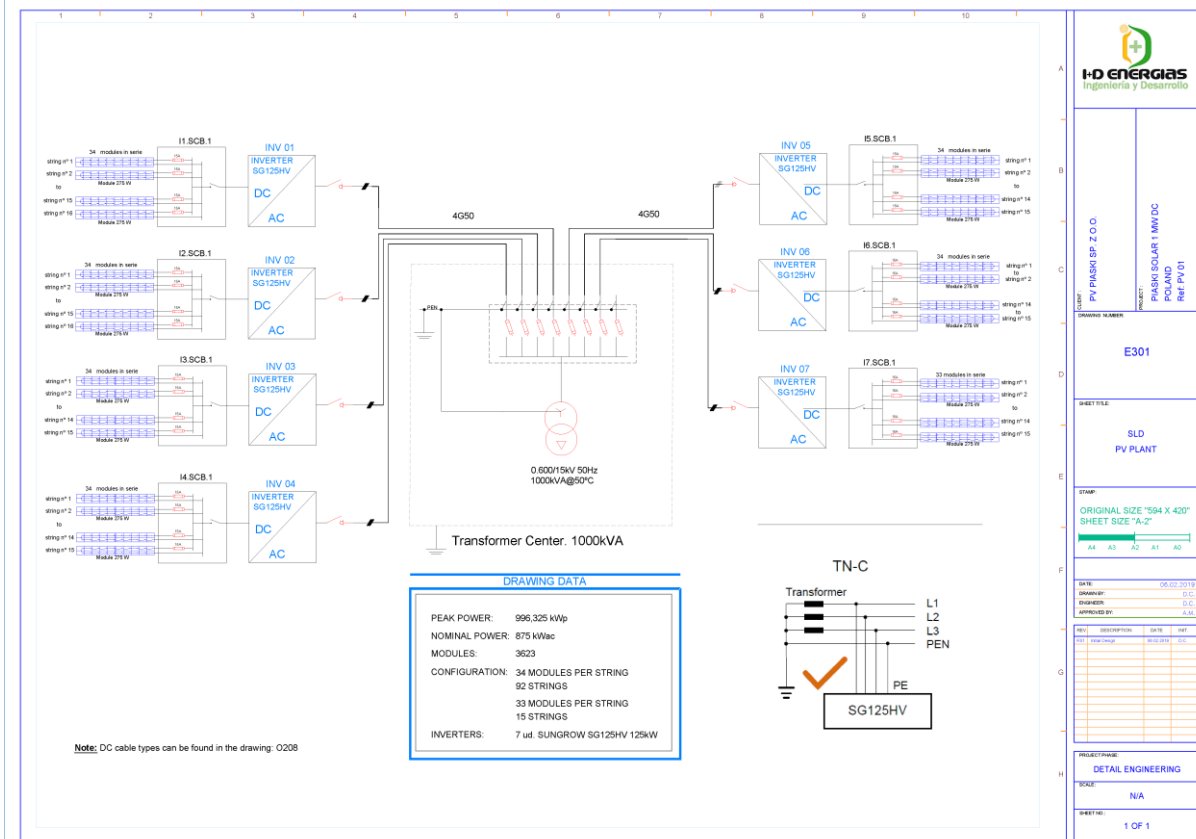


**Image 3: Module Connection Detail for Type 1 (68 positions) and Type 2 (36 positions) tables, with 34-panel strings making a C and zig-zag connection respectively. [company source]**

In Energija dossier there are also some strings composed of 33 panels instead of 34, because we cannot reach the peak power of 1 MW, though we can be as close as possible without reaching 1 MW peak (1 MWp). So, these 33-panel strings leave 2 gaps at big-size tables (“Type 1”), and 3 gaps at small-size tables (“Type 2”), as it happens to the SCB 7 shown at Image 4.

The following images present the construction of individual farm elements as well as the entire architecture of the photovoltaic farm. For instance from technical drawing we see that the direction of string is marked with red arrows and runs in one direction (Image 7). The same direction appears in electrical architecture, because this solution is more convenient for trenches.

Furthermore, the cabling architecture is based on aluminium cables for positive and negative poles, so the cost per meter is optimised with respect to copper cables.



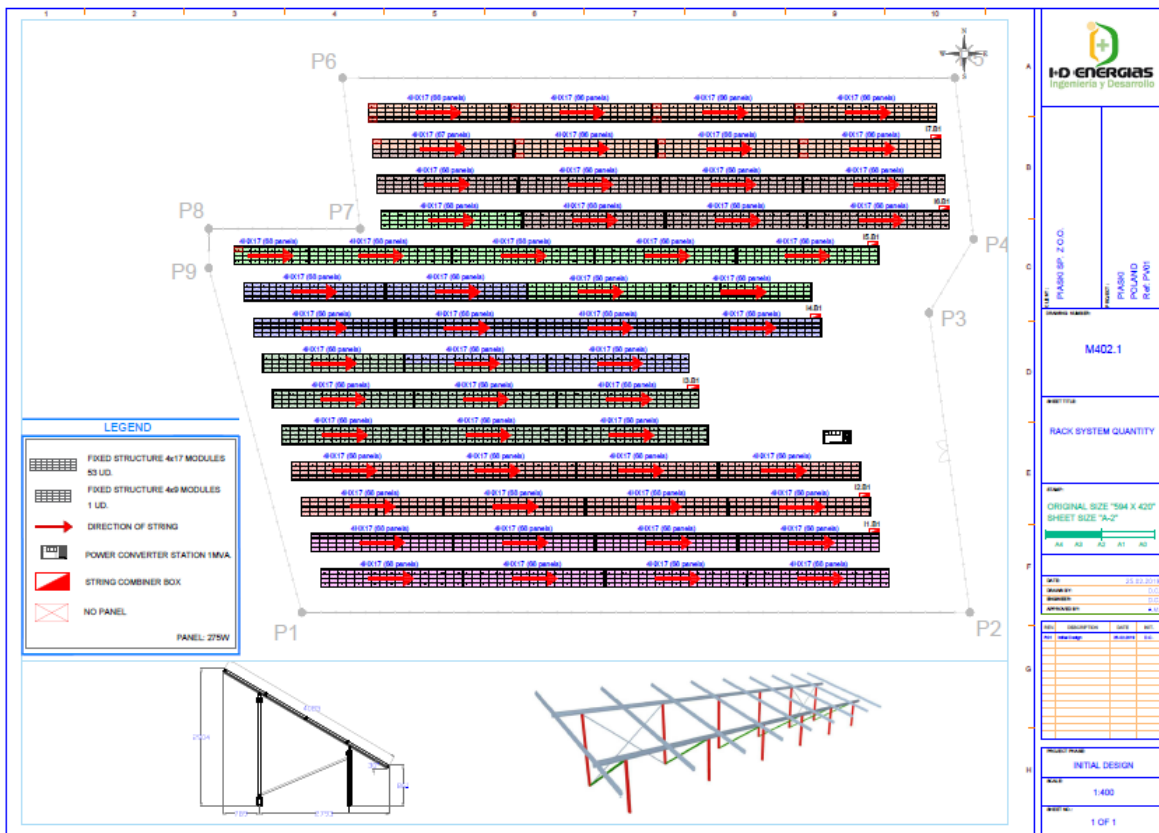
**Image 4: LV Single-Line Schema for a PV farm: SCBs 1 and 2 are composed of 16x34-panel strings, SCBs 3 to 6 are composed of 15x34-panel strings and SCB 7 is composed of 15x33-panel strings, so total peak power must be slightly under 1 MW. [company source]**



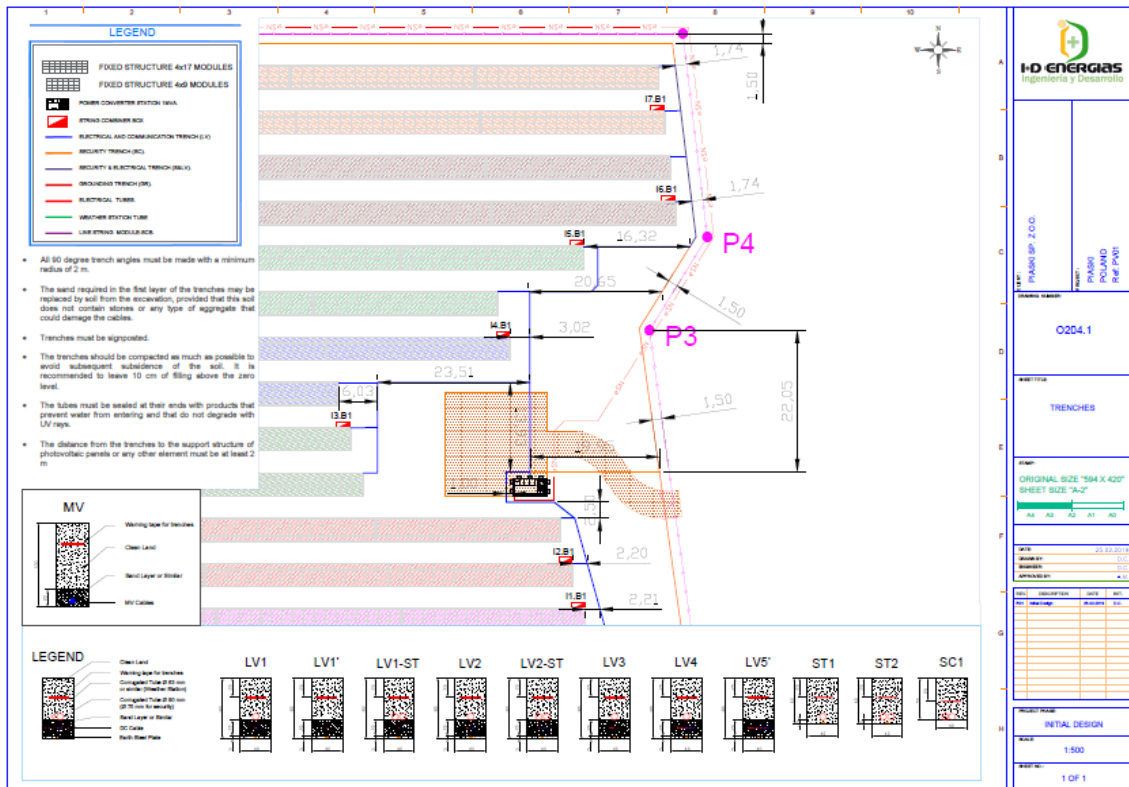
**Image 5: Piaski 1 MW PV farm photo taken with a drone (1). [own photo]**



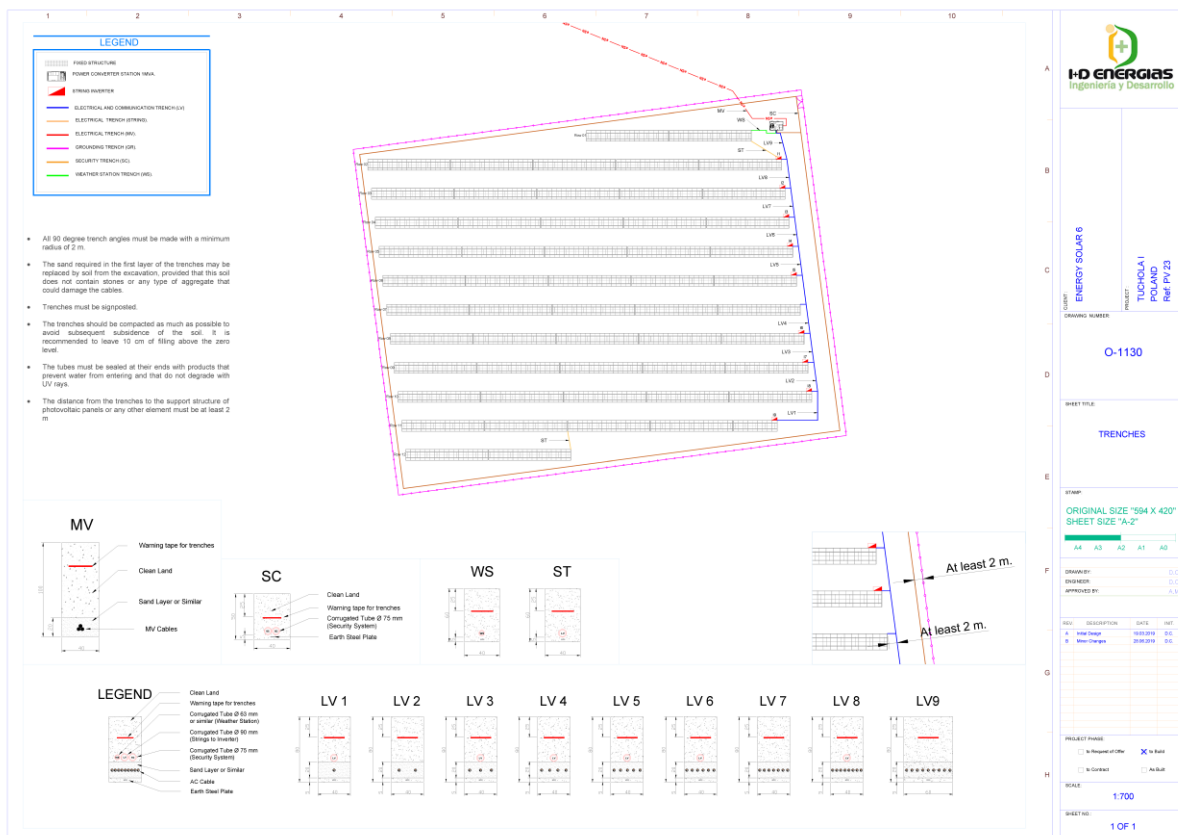
**Image 6: Piaski 1 MW PV farm photo taken with a drone (2). [own photo]**



**Image 7: Structure layout of Piaski solar farm. Red arrows show the way how the strings are connected to the SCBs. [company source]**



**Image 8: Scheme of electrical trenches and internal road in Piaski Photovoltaic Farm.**  
[company source]



**Image 9: Trenches scheme for the cabling for one photovoltaic farm:**  
LV: Low Voltage – ST: String Extension – MV: Medium Voltage – SC: CCTV – WS: Weather Station.  
[company source]

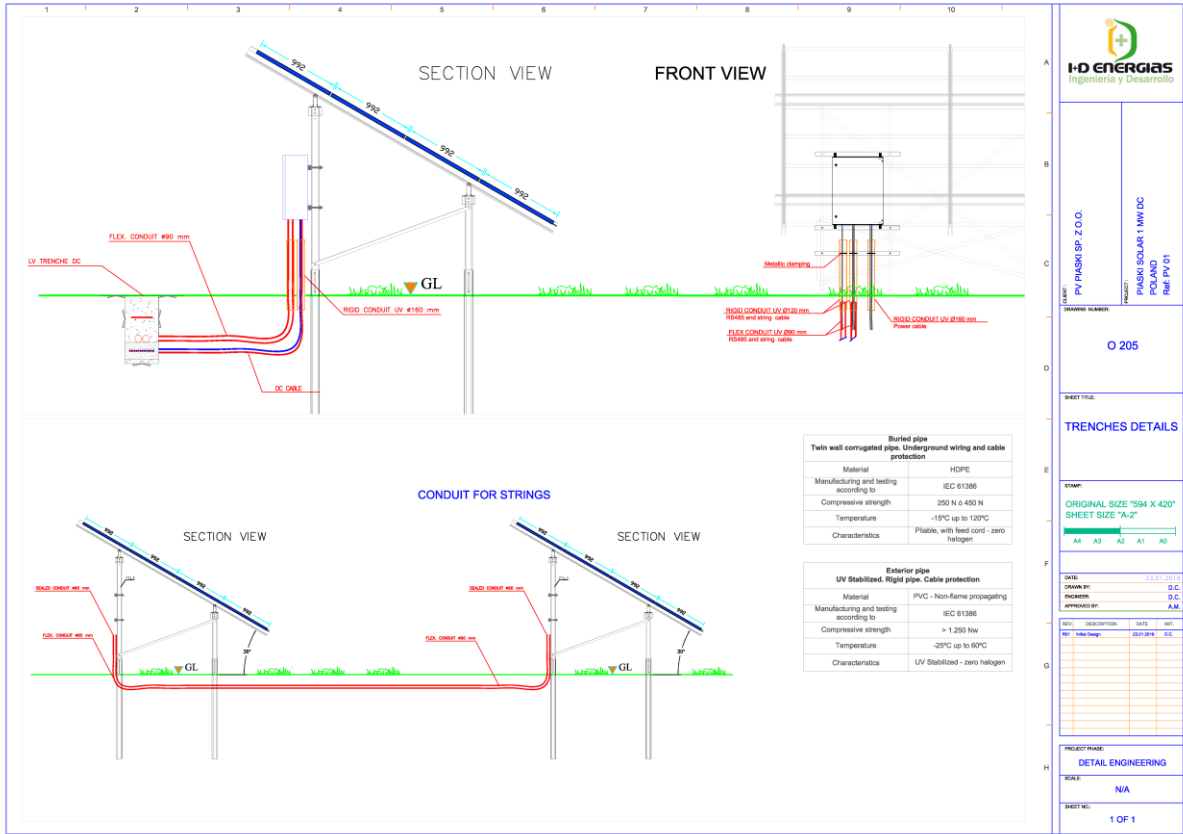


Image 10: SCB Details: Trench section, underground cable and supporting frame. [company source]

## 2. INVERTERS PRODUCTION AND METEO MONITORING

### 2.1. Inverters used: Sungrow vs Huawei architectures

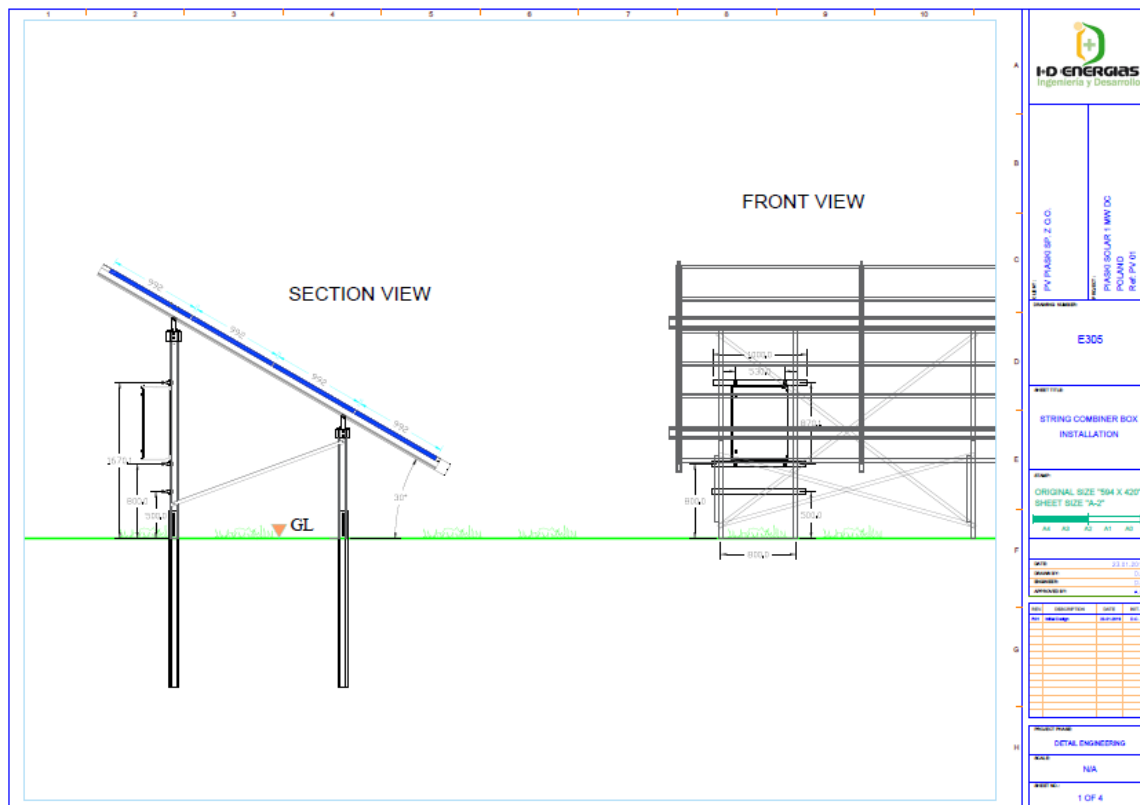
As mentioned in chapter 1, I+D Energías' whole Polish portfolio consists of 109 projects of 1 MW solar farms each. This portfolio is divided into 2 project networks for 2 different investors: Energija (43 MW) and Lords (66 MW). Therefore, we build 2 different system architectures for each one of them. For Energija projects we work with 125 kWn Sungrow inverters and for Lords projects, the chosen inverter is Huawei 105 kWn. Each inverter works in a very different way from the other one for what concerns to working points and communication architecture, as explained next.

### 2.2. Energija architecture: SCBs and Modbus connection

For Energija projects we install String Combiner Boxes (SCB) which are connected directly with the solar panel strings, acting as DC concentrators (Image 11). From SCBs, electrical energy is transported by DC cables to Power Station. These DC cables are aluminum-made and unipolar. One of the poles is positive, while the other one is negative.



*Image 11: String Combiner Box mounted over photovoltaic structure. [own source]*



**Image 12: SCB Installation for Energija Projects:  
Front and section view of mounting process. [company source]**

Then energy is converted from DC to AC by Sungrow Inverters and it goes to the trafo station where it will be converted from LV-AC (Low Voltage) to MV-AC (Medium Voltage), and then it is injected into the electrical grid to be sent to the client's networks. All Sungrow Inverters are attached to the Trafo Station as shown in Images 16 and 17.

For each Inverter there is one SCB because 125 kWn Sungrow inverter works with 1 single input (one working point or MPP, from Maximum Power Point). So the SCB is a necessary concentrating element for our purposes.

This means that all the strings connected to the same SCB (and therefore, to the same inverter) must have the same number of panels and the same tilt angle. Different tilt angles would introduce different working points (because the irradiation conditions vary), and Sungrow inverter would not be optimized.

The SCB Box Single Wire Schema is presented in the Images 13 and 14.

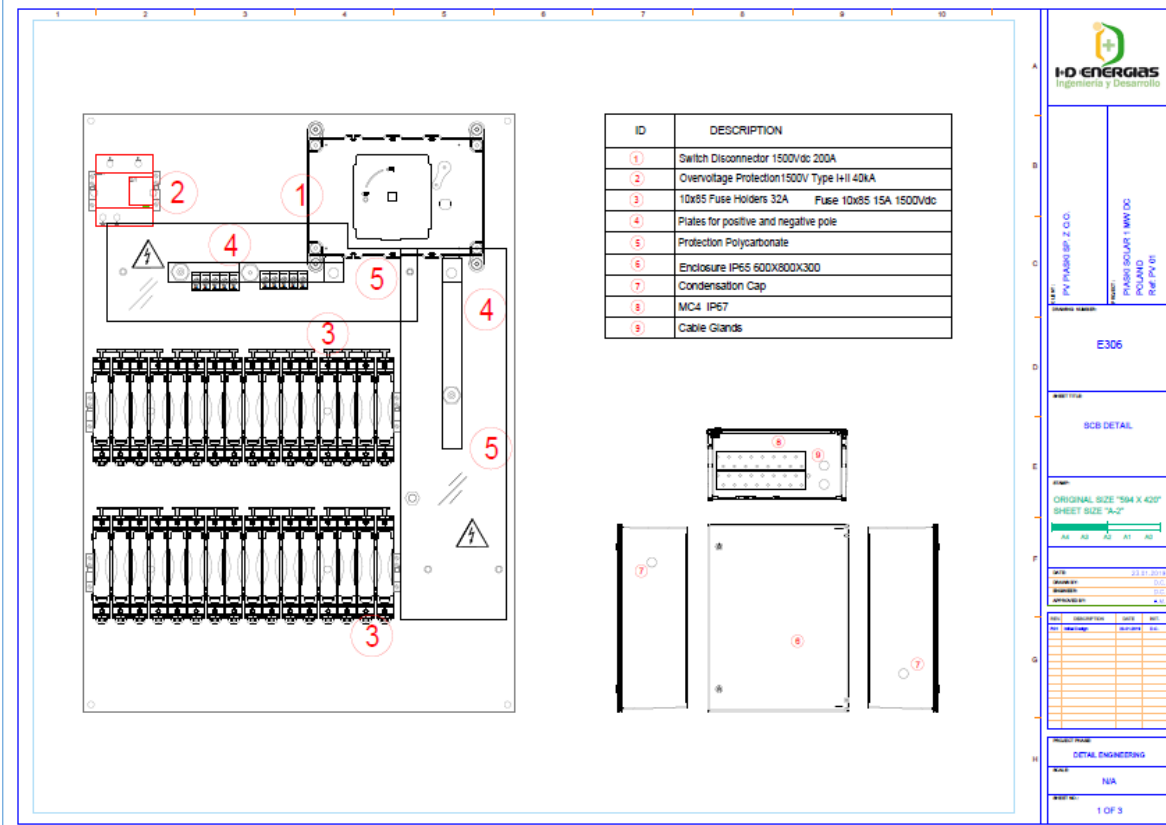


Image 13: SCB Box Single Wire Schema (1). [company source]

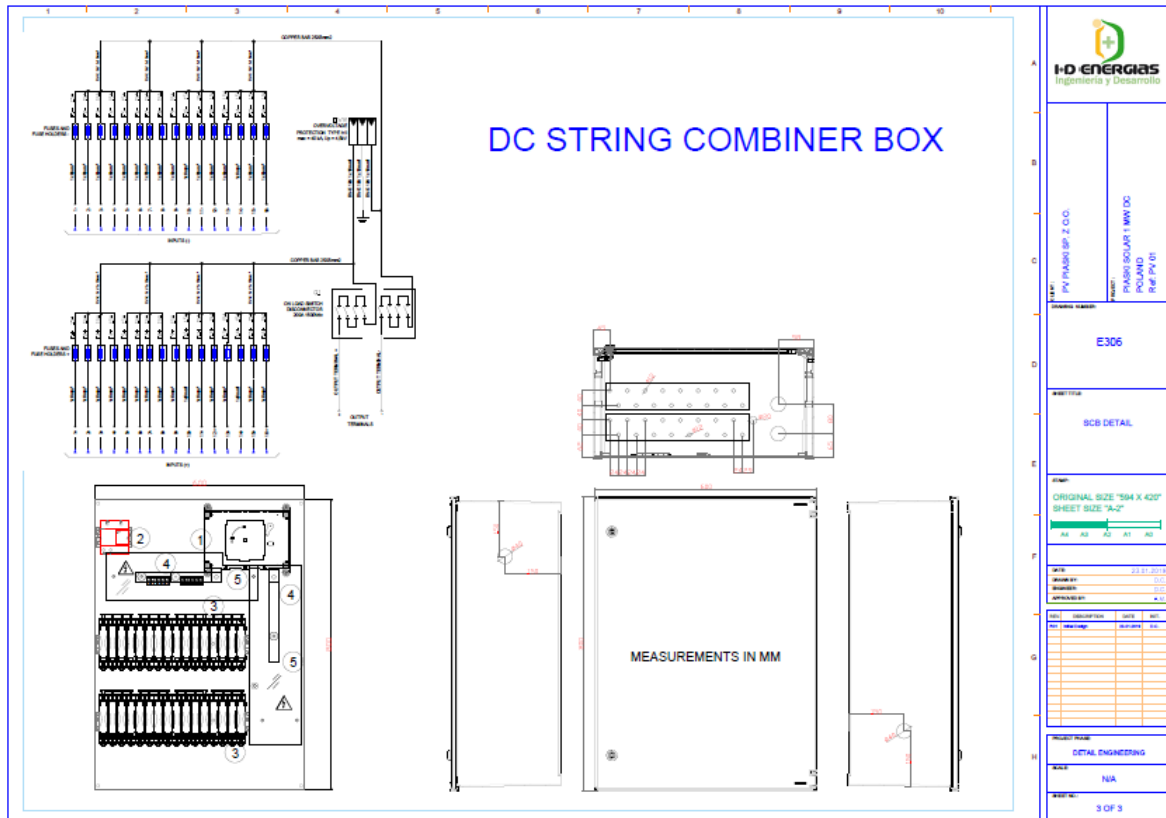


Image 14: SCB Box Single Wire Schema (2). [company source]



## 2.2.1. Student work for Energija architecture: SCBs and Modbus connection

String Combiner Boxes have been configured and installed for each solar panel string. We had to properly connect the cables to the corresponding ports inside the SCB. After connecting, we described and secured the connections. This process was similar for all SCBs on a photovoltaic farm.

The next step was to connect one SCB with one Sungrow inverter (which is at Trofo Station), because only in this configuration (one to one) it can work. The whole process involved the appropriate cables communication connection for a modbus inverter, which is explained in Images 20 and 21.

In Energija Projects Portfolio, monitoring boxes were used to supervise and control the work of inverters. All components inside the monitoring box have been connected and optimized to run a monitoring system for the photovoltaic farm.

The operation of the system for the photovoltaic farm was checked before the end of the project and its commissioning.



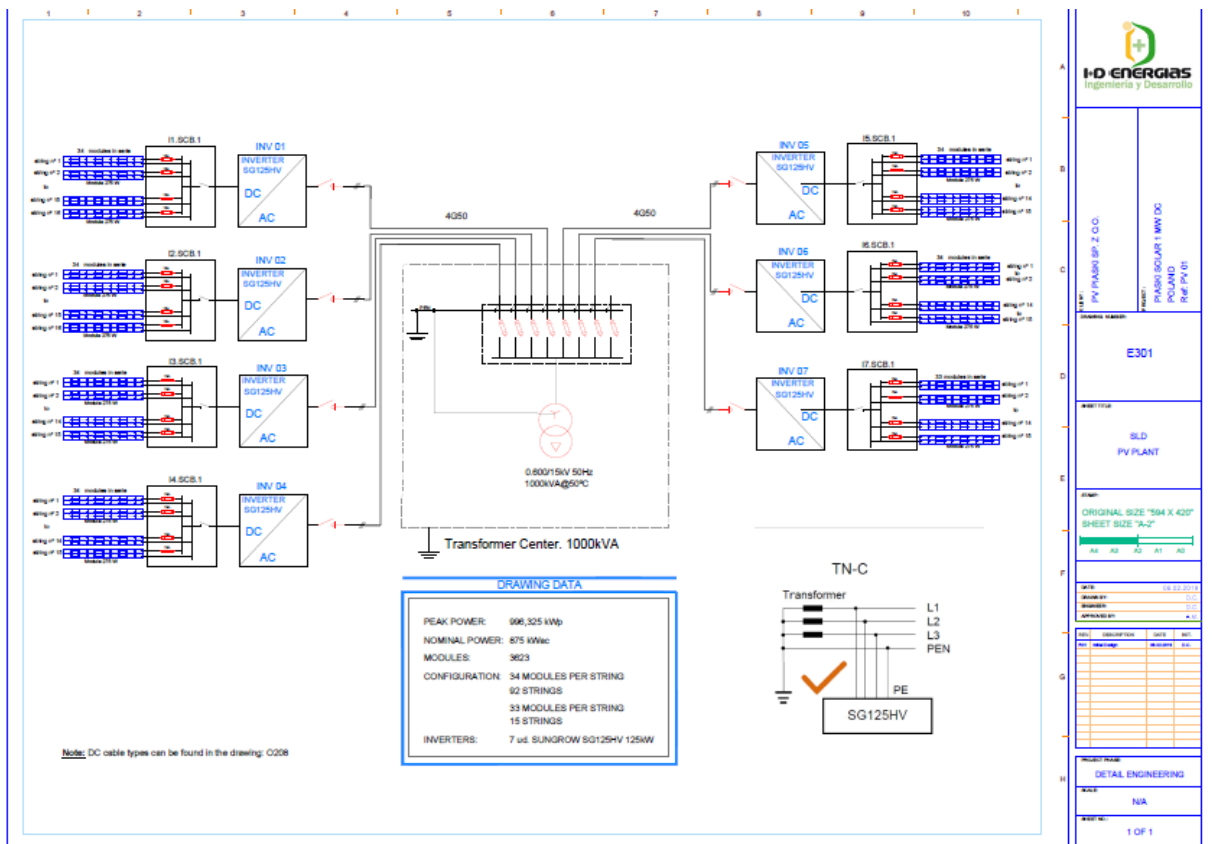
*Image 15: Interior of String Combiner Box. [own photo]*



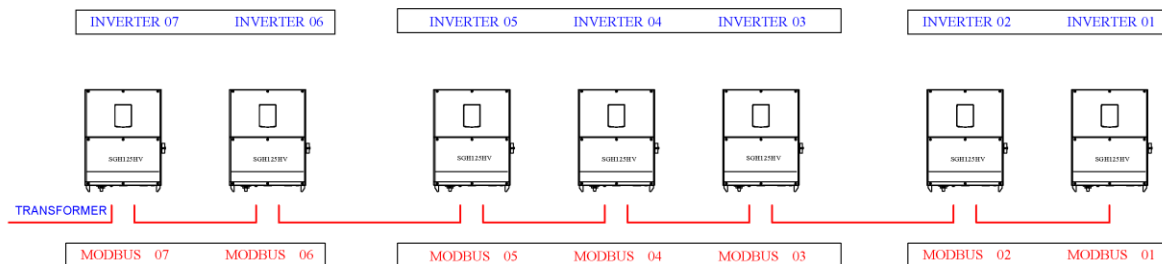
To explain how the communication system for Sungrow Inverter works, we can consider Images 18 to 21. The inverter has two communication waterproof connection terminals. Inside the junction box, there are RS485 “A” and “B” terminals and RS485 interface on the configuration circuit board.

Through the dip switch, we must connect a 120 Ω termination resistor between the A and B communication cable in the last inverter, since there is no input signal from any other, to adapt the input impedance, as shown at Image 21.

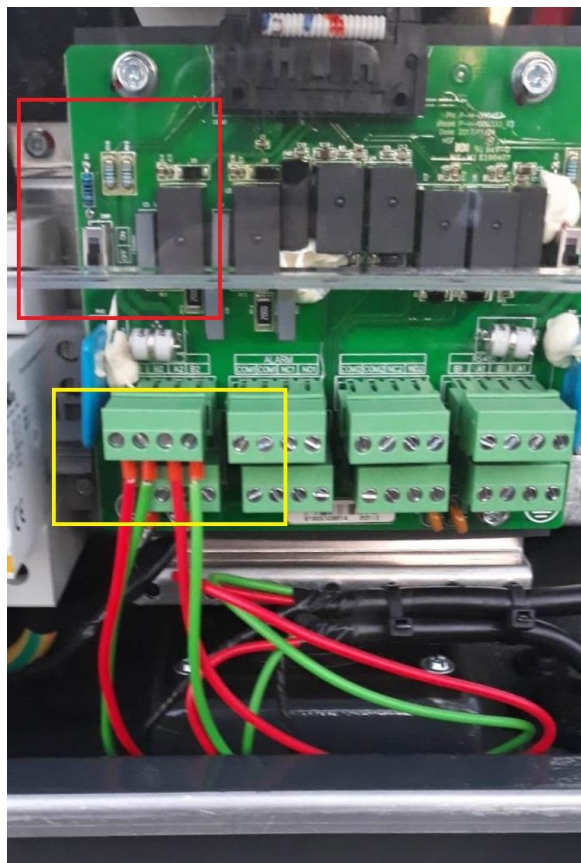
Thanks the appropriate software that will be explained in chapter 2.5 and through RS485 (also called Modbus or “daisy chain”) communication interface, we collect the information of the inverter operation. There is also a single- point grounded for the shielding layer of the RS485 cable.



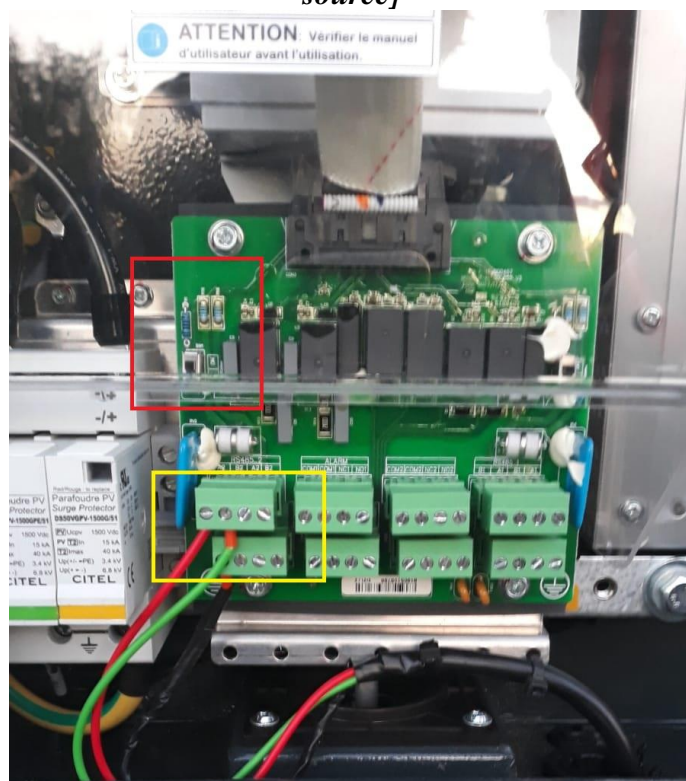
**Image 18: Single line scheme for Energija projects from strings up to the Trafo Station. [company source]**



**Image 19: Modbus connection for String Inverters in Energija projects. [company source]**



**Image 20: Communication connection for middle (all but the last) modbus inverter. In yellow box, input and output signals. In red box, 120  $\Omega$  resistor switched off. [own source]**



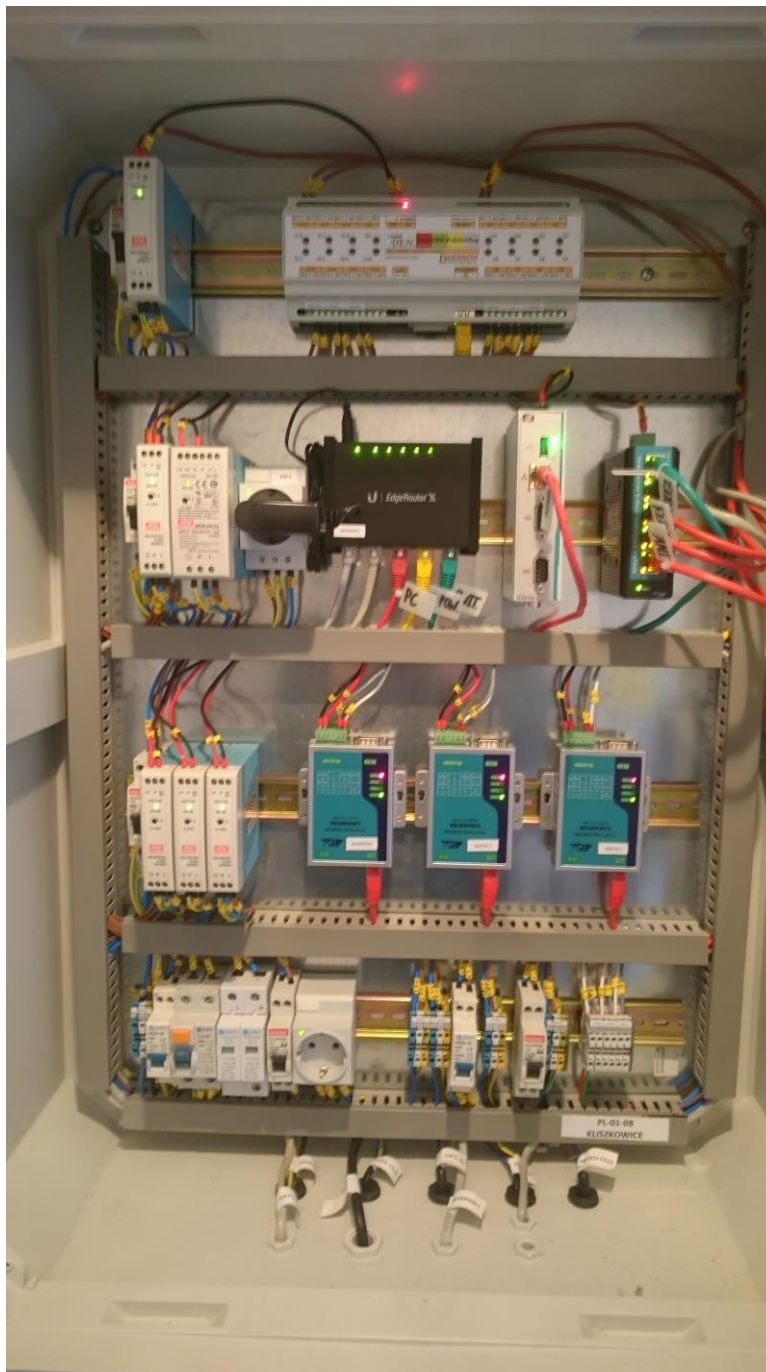
**Image 21: Communication connection for last modbus inverter. In yellow box, output signal. In red box, 120  $\Omega$  resistor switched on, to adapt the input impedance. [own source]**

In Energija projects, monitoring boxes are responsible for monitoring and controlling about the every inverters' work, as well as the Meteo Box that will be explained in Chapter 2.5. Inside the monitoring boxes we can find the different communication components shown at Image 22, from which we can detach:

- IP Serial: Is enabling perfect integration with the central computer. Thanks a built-in terminal program, users can send, receive command and data via the terminal programme for easy testing. The cabling is much easier and total costs of cable and switch are significantly reduced.
- IP Power: Device to monitoring up to 16 hosts' availability: PC, routers, switches and cameras.
- Router: First step before the general gateway to the Internet. Enables remote monitoring systems in photovoltaic farms.
- Mini PC: Small-size personal computer, to control all the devices that act as its peripherals. There is usually no screen connected because a laptop can be used also to make the monitoring in local mode, as shown in Image 23.
- Power Supply for all the devices.

And whose datasheets are available at Annex 1

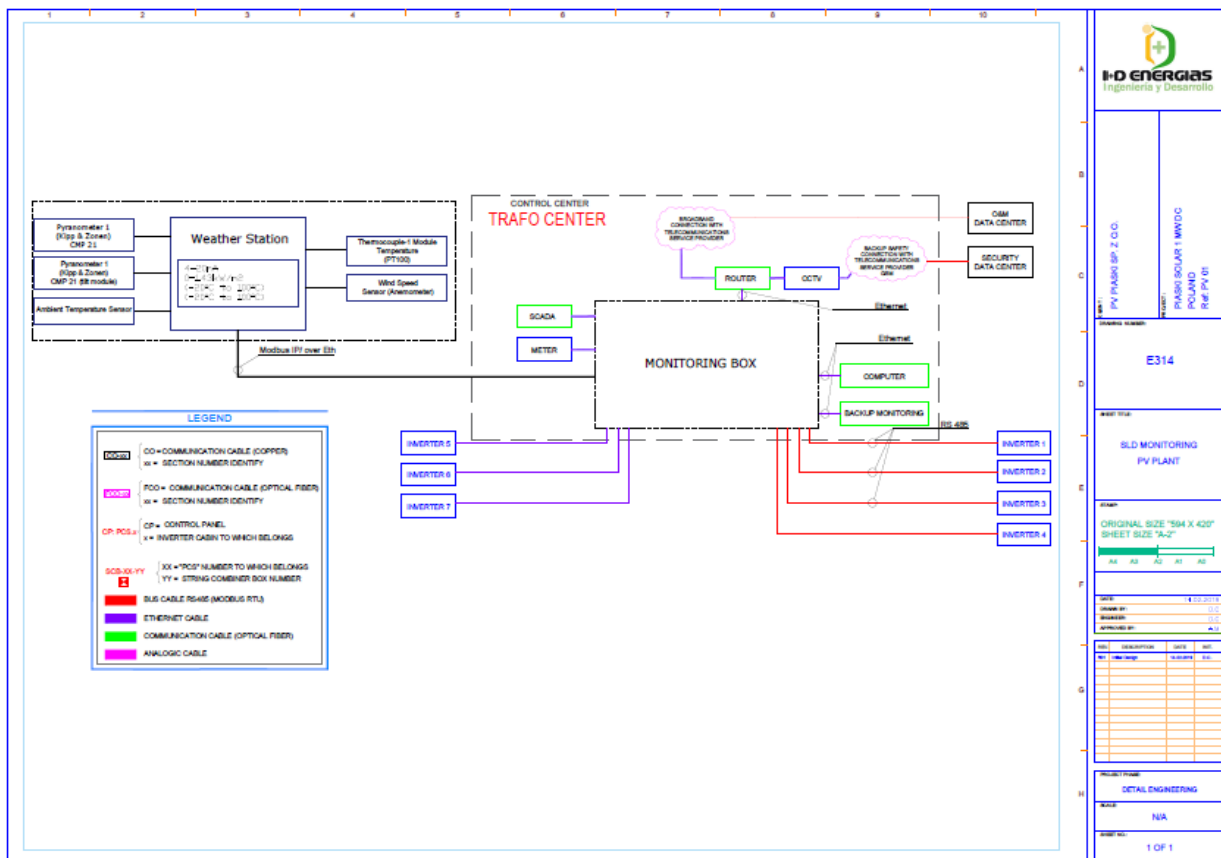
One monitoring box is responsible for all the inverters of the solar farm. Below is presented a monitoring box interior with working components.



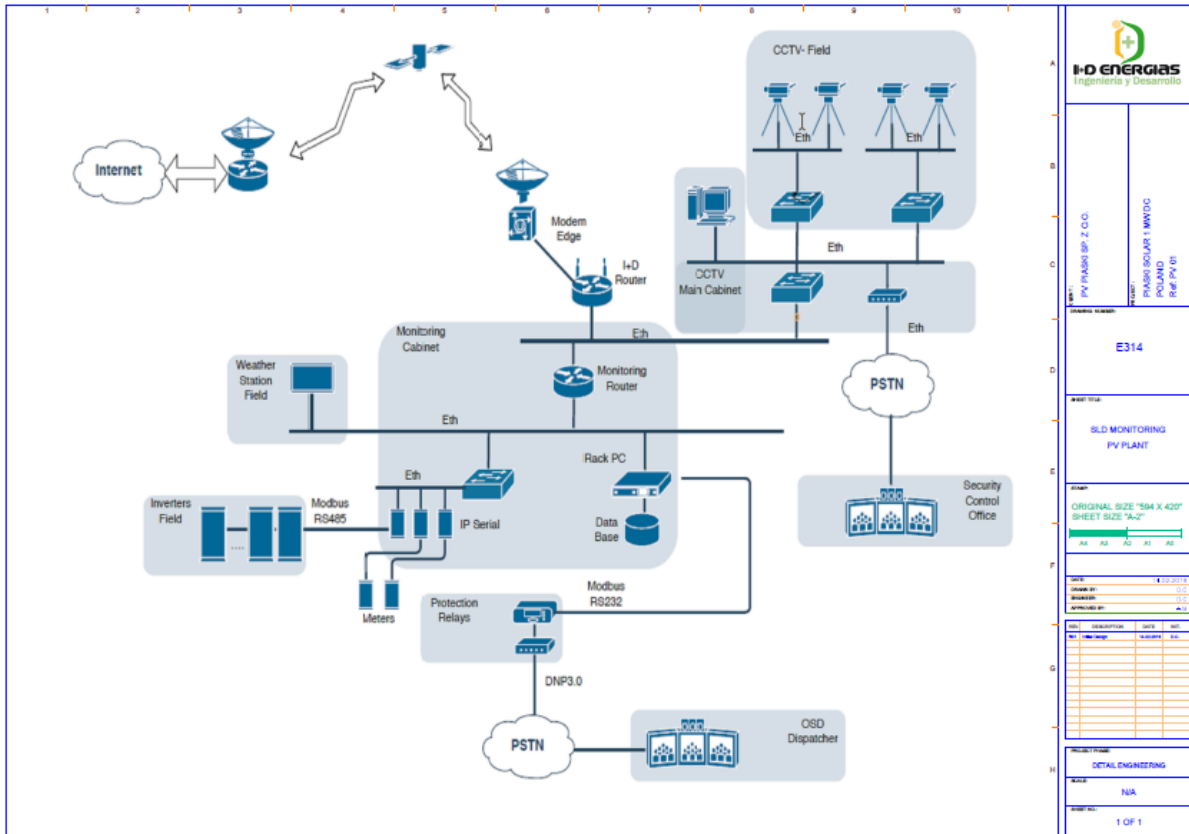
***Image 22: Components inside a monitoring box: Top shelf: IP Power, Second shelf, from left to right: Power Supply, Edge Router, PC, IP Serial. [own source]***



**Image 23: Monitoring System inside the Transformer Station with a laptop connected.**  
[own source]



**Image 24: Monitoring Diagram for Energija projects through the monitoring box.**  
[company source]



*Image 25: General Monitoring Diagram for Energija Projects. [company source]*

## 2.2.2. Bulleted conclusions list for Energija architecture: SCBs and Modbus connection

String Combiner Boxes have been configured and installed for each solar panel string.

The connections were described and secured.

Each SCB is connected to its respective Sungrow inverter.

Components inside the monitoring box have been connected and optimized to run a monitoring system for the photovoltaic farm.

## 2.3. Lords architecture: String Inverters and PLC connection

For Lords projects, inverters are located throughout the solar farm, attached to the structures, and communication with them is made by AC cable itself by following PLC (Programmable Logic Controller) protocol, a robust solution, so the attenuation level is not significant.



PLC architecture starts from the busbar connections that are present inside the Trafo station, as shown at the images 26 and 27. The busbar architecture is composed of 9 input AC connections from the 9 inverters that are placed throughout the solar farm.

### 2.3.1. Student work for Lords architecture: String Inverters and PLC connection

The Lords Project Portfolio was a completely new project with new technical solutions related to farm architecture. Therefore, in these projects it was necessary to monitor the implemented solutions and to look for new and better solutions on an ongoing basis.

Modern Huawei Inverters were used in Lords Project Dossier, new technological solutions for projects were introduced. Among others, the Programmable Logic Controller (PLC) has been implemented, this solution is more expensive, but thanks to the robust solution, it is much more durable and safer, because there are no hand-made fuses.

Busbar connection for 9 inputs has been connected in the PLC architecture, because 9 inverters are common in Lords Project Dossier.

In the PLC Architecture for Huawei inverters from the Busbar connection, power and monitoring signals are split up. Signals are sent to Smartlogger which was implemented for Lords Project Dossier.

At the client's special request, special additional protection of cables and connections between them against UV radiation and weather conditions was invented and implemented.



***Image 26: 9-inverter busbar architecture inside the trafo station. [own source]***

The reason why there are 9 inverters is because the nominal power of each one is 105 kWn, so the whole nominal power is  $9 \times 105 = 945$  kWn, slightly close to 1 MWn but still under.



Image 27: PLC connection to the 9-inverter busbar architecture. [own source]

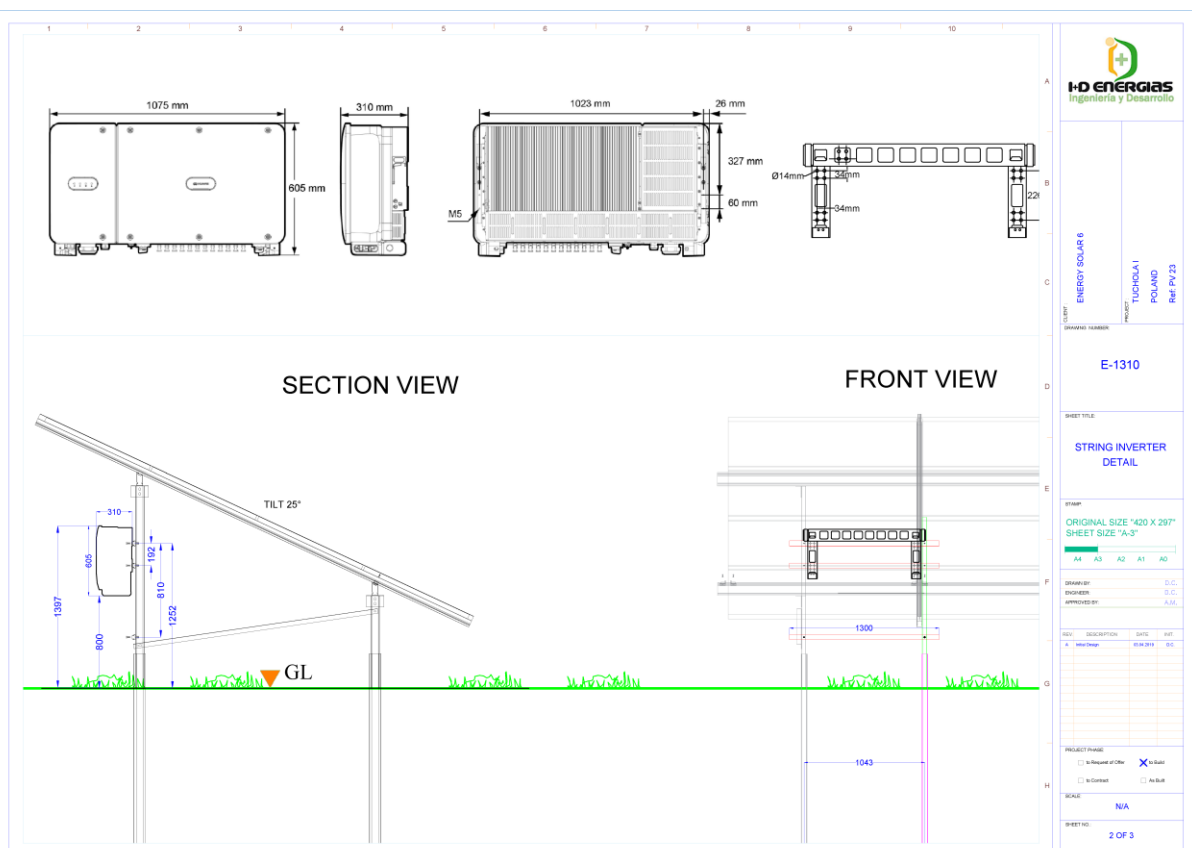


Image 28: String Inverter architecture for Lords dossier. Inverters are attached to the structures throughout the solar farm. [company source]

In the Image below we can see the Huawei 105 inverter installed, attached to the structures where solar panels are placed. For Lords projects, the String Combiner Box (SCB) is the Inverter itself so there is no need of placing an independent SCB.



***Image 29: Huawei Inverter for Lords project.  
In the left side, the 3-phase AC cable containing the monitoring signal. [own source]***

There are 9 inverters per solar farm in Lords architecture, as shown at the picture below.



***Image 30: Joint of 9 Huawei Inverters on a Lords photovoltaic farm. [own source]***

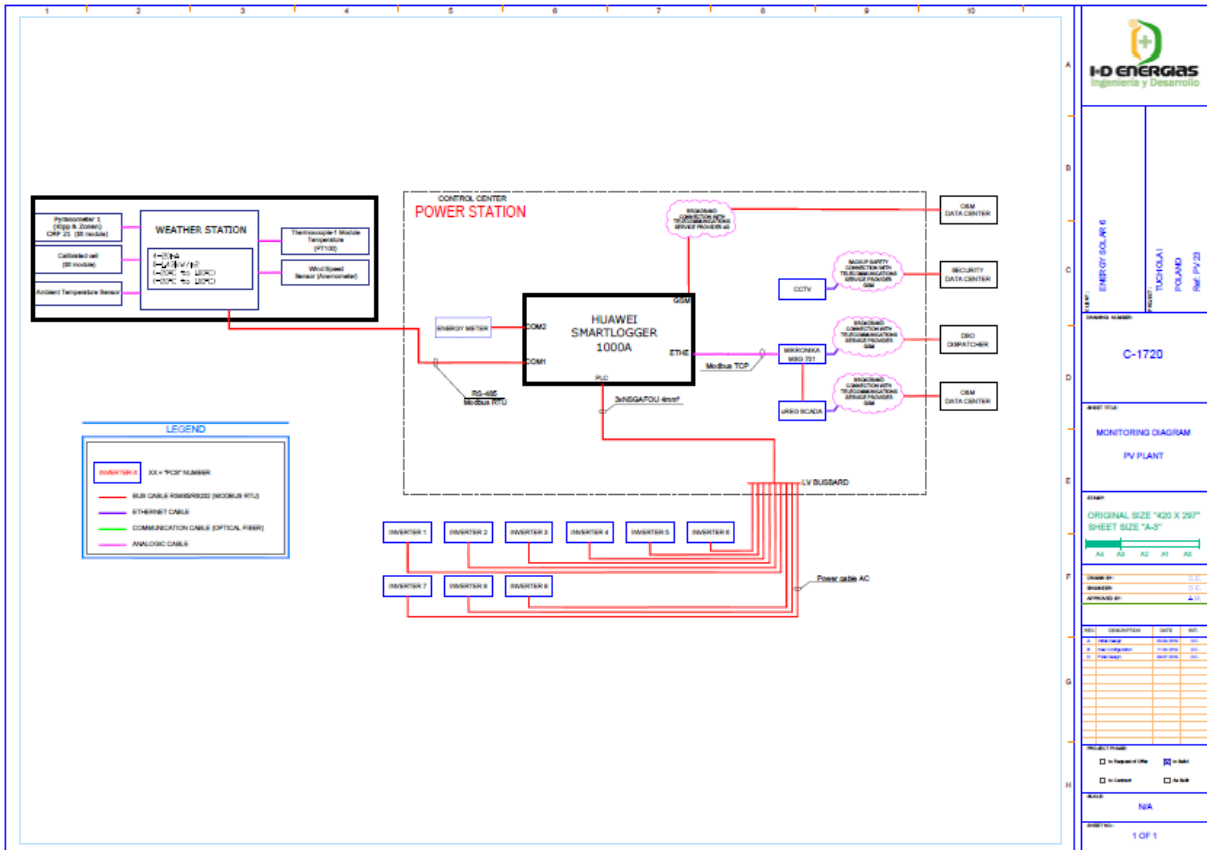


Image 31: Monitoring Diagram for Lords projects through Huawei's Smartlogger. [company source]

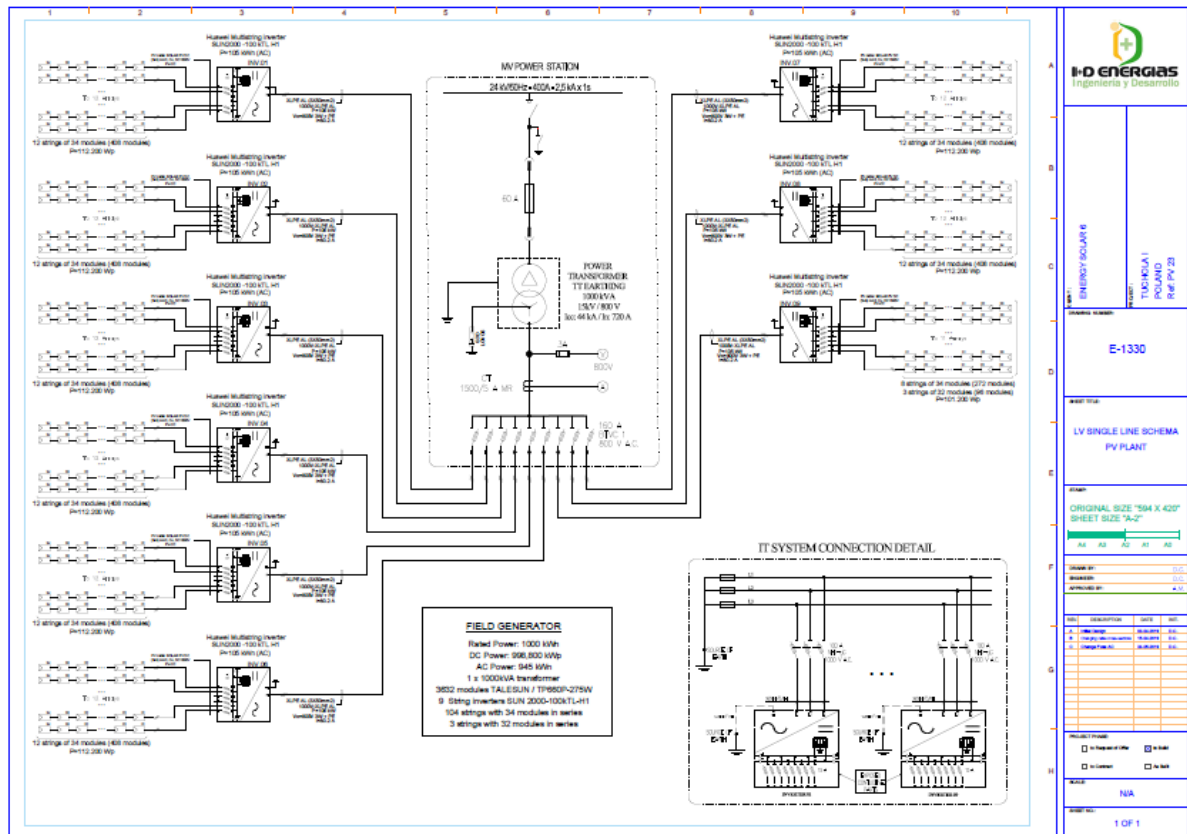
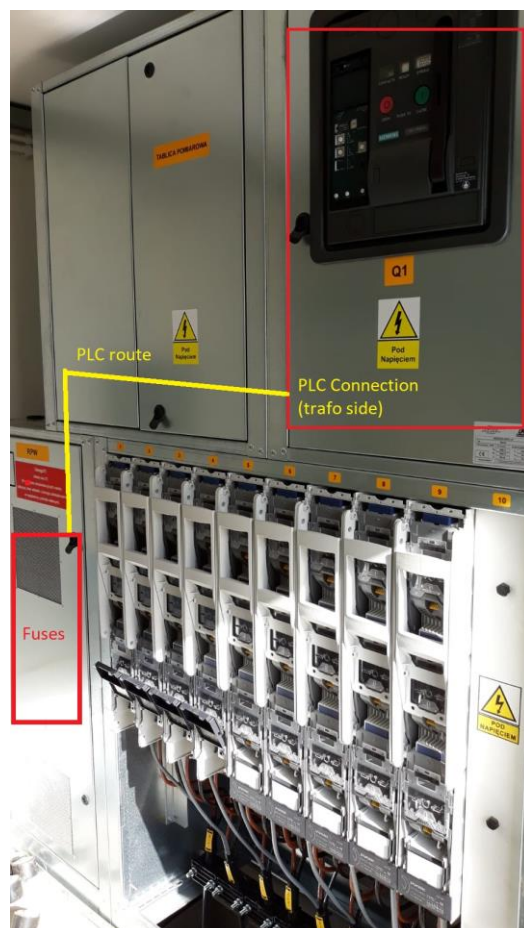


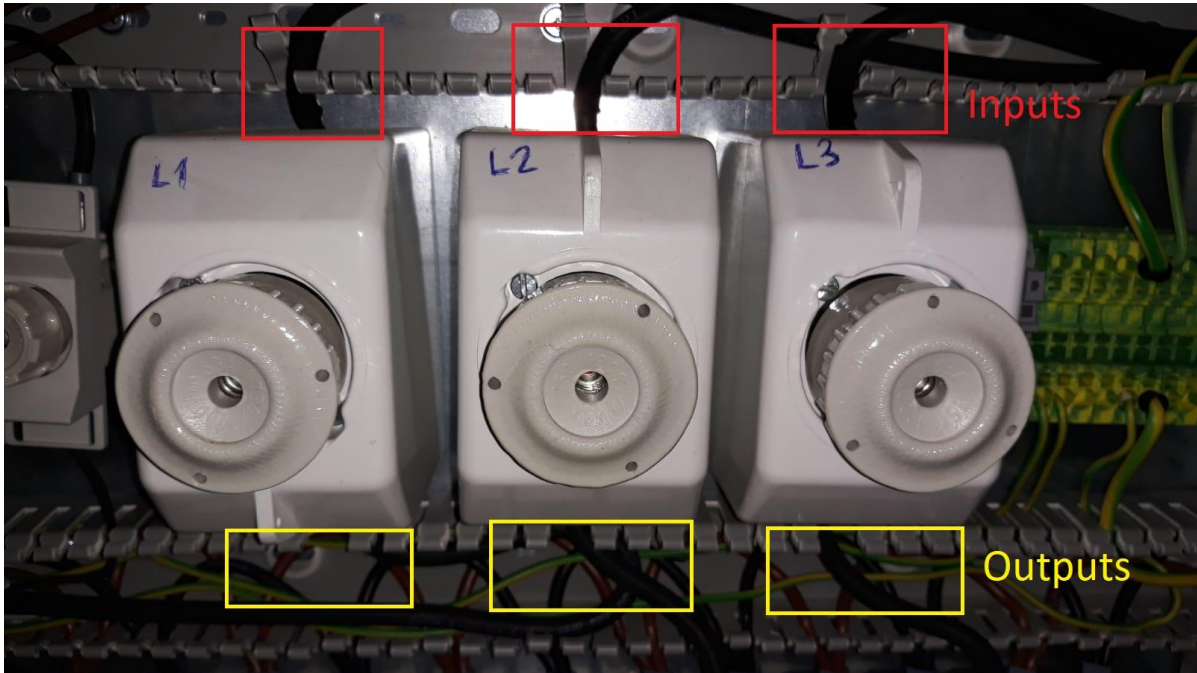
Image 32: Single Line Schema for Lords projects from strings up to the Trafo Station. [company source]

This communication through PLC protocol is possible because Huawei 105 kWn inverter is compatible with this technology. Otherwise, Modbus or Fiber Optics systems would be necessary.

Modbus solution is not a good option for Lords projects because inverters are spread throughout the solar farm and long distances do not make this solution a good option.

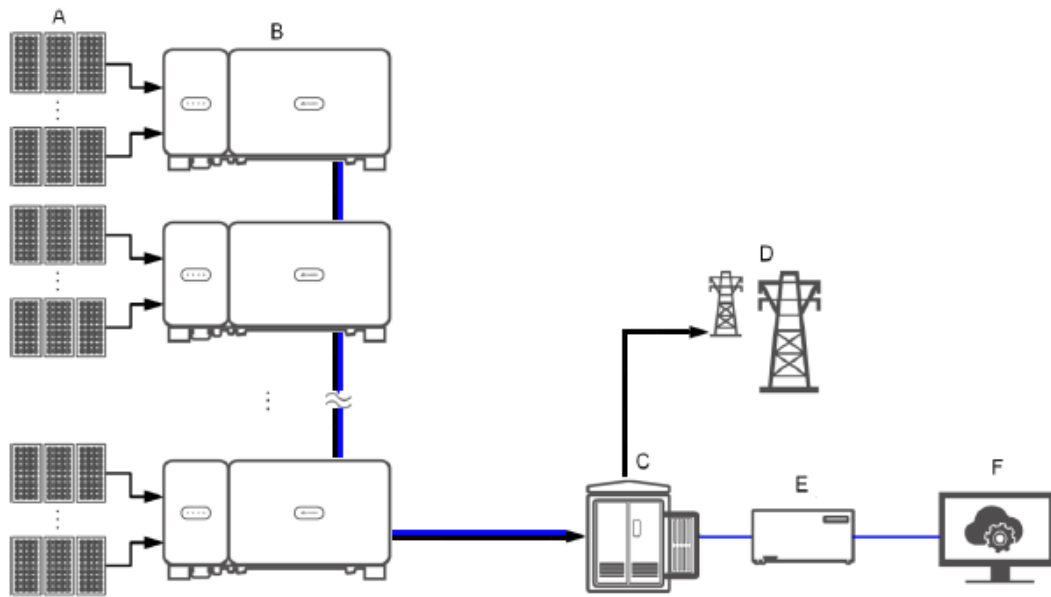


***Image 33: First section of PLC cable routing between the Busbar and the Huawei Smartlogger device, up to the PLC Fuse System. [own source]***



**Image 34: 3-Phase Fuse system for PLC protocol, to protect Huawei's smartlogger from Busbar overvoltages. [own source]**

The Image below shows the system built on photovoltaic farms for the SUN2000–105 KTL model which we installed at Lords dossier.



**NOTE**

— indicates a power cable; → indicates the power flow direction; — indicates a signal cable.

(A) PV string

(B) SUN2000

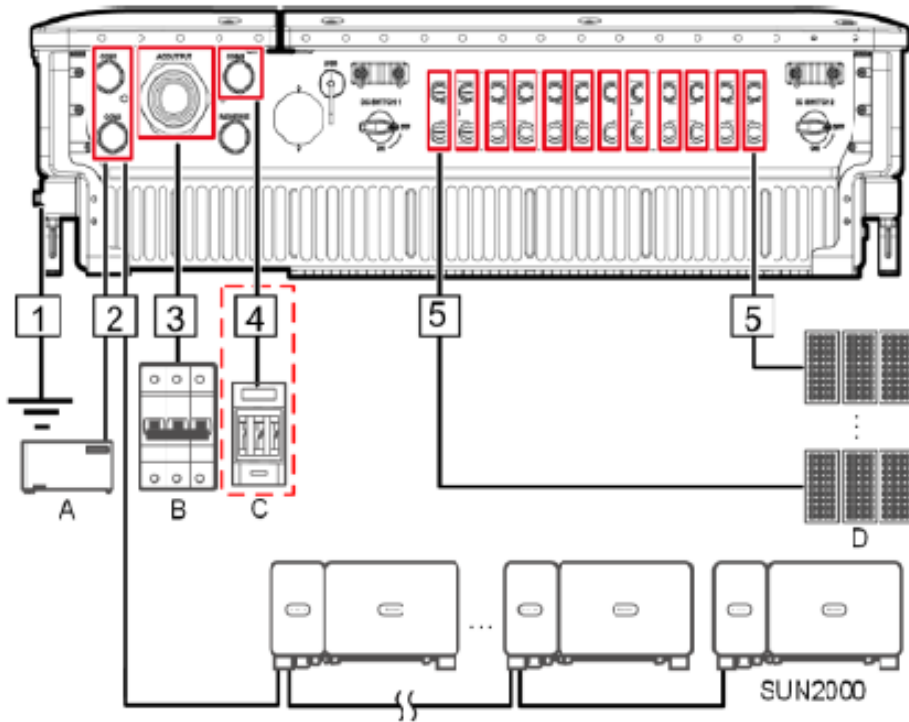
(C) Busbar connection

(D) Power grid

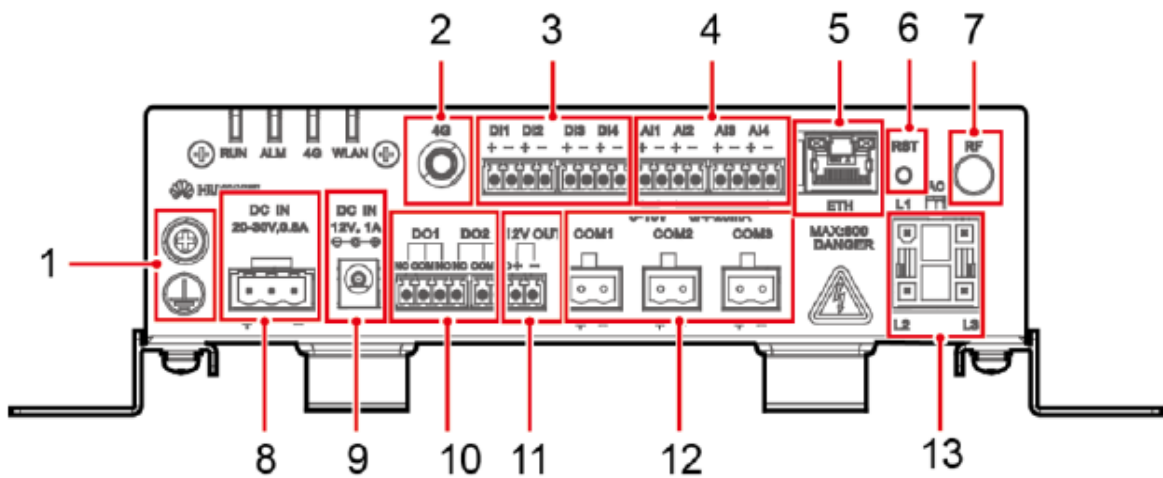
(E) SmartLogger2000

(F) Management system

**Image 35: PLC Architecture for Huawei inverters. At point (C), from the Busbar connection, power and monitoring signals are split up. Signals are sent to Smartlogger (E). [Huawei manual]**



*Image 36: SUN2000 Inverter's bottom connections. [Huawei manual]*



*Image 37: Rear view schema of Huawei's Smartlogger. Connection number 13 corresponds to PLC inputs, used in Lords projects. [Huawei manual]*



*Image 38: Rear view picture of Huawei’s Smartlogger. [own photo]*

As mentioned earlier the inverters for Energija and Lords projects can be controlled in local mode by an external application:

- For Energija dossier (Sungrow) we use “10 Sun Access “application.
- For Lords dossier (Huawei) we use “SUN2000” application.

These applications are just needed when we are making an on-site initial configuration, from that point on all the rest is made in remote mode.

Both of them are available at PlayStore.

### 2.3.2. Bulleted conclusions list for Lords architecture: String Inverters and PLC connection

Modern Huawei Inverters were used in Lords Project Dossier, new technological solutions for projects were introduced. The Programmable Logic Controller (PLC) has been implemented.

Busbar connection for 9 inputs has been connected in the PLC architecture. The Smertlogger have been implemented for Lords Project Dossier.



Special additional protection of cables and connections between them against UV radiation and weather conditions was invented and implemented.

## 2.4. Student analysis: Comparison between both architectures

For Energija Projects we used Sungrow Inverters and tailor-handmade String Combiner Boxes. Because of that, jointly with the huge number of fuses, the probability of fail is higher.

This solution in Energija Projects is cheaper, but less optimized in comparison with Lords Projects.

When we consider Lords Projects we see stronger and more optimized system, all system architecture is different, more convenient, but unfortunately more expensive. For Lords we used Huawei Inverters which are wholly manufactured by the Huawei Corporation. Thanks to these robust devices, the probability of the fail is lower than in Energijas case.

We used here AC cables, whose price is higher than DC cables. AC cables are multipolar and have 3 independent phases.

In the Lords projects were applied string inverters with up to 8 working points (up to 16 inputs). One working point –Maximum Power Point (MPP)– contains  $V_{mpp}$ ,  $I_{mpp}$  and depends on the quantity of solar irradiation, tilt angle of the panels and azimuth. The solar energy from photovoltaic panels goes to the string inverters which change energy from DC to AC. After this conversion, AC energy is carried up to Trafo Station. Thanks to transformer, MV electricity is obtained, which goes directly to the utility network.

In Energija dossier, typical configuration is composed of 7 inverters and their respective 7 combiner boxes. There is only one working point for all the 16 inputs, this means that for one inverter all the strings must have the same number of panels and similar irradiation conditions. Each inverter, or each Combiner Box, is therefore composed of:

- 16 strings per inverter (or 15 in some cases),
- 34 panels / string (or 33 in some cases),
- panel peak power  $P_p = 275 \text{ Wp}$ ,

so, from the equation we obtain a typical value of  $16 \cdot 34 \cdot 275 = 149.6 \text{ kWp}$  per SCB,

and total  $7 \cdot 149.6 = 1047.2 \text{ Wp} = 1.047 \text{ MWp}$ .

Nominal power:  $7 [\text{inverters}] \cdot 125 [\text{kWn/inv}] = 875 \text{ kWn} = 0.875 \text{ MWn}$

% of  $P_p$  [peak power] /  $P_n$  [nominal power] =  $1047/875 = 1.196 \approx 119.6 \%$

In Lords dossier there are 8 working points per inverter; therefore, 16 inputs and 2 inputs per one working point. Both inputs of the same MPP must have the same number of panels and similar irradiation conditions. There are typically 9 inverters per solar farm, and they are composed of:

- 14 strings per inverter,
- 34 panels / string (or 33 in some cases),

- panel peak power  $P_p = 275 \text{ W}_p$ ,

so, from the equation we obtain a typical value of  $14 \cdot 34 \cdot 275 = 130\,900 \text{ W}_p$  per SCB,

and total  $9 \cdot 130.9 \text{ kW}_p = 1\,178\,100 \text{ W}_p = 1.178 \text{ MW}_p$

Nominal power:  $9 \text{ [inverters]} \cdot 105 \text{ kW}_n = 945 \text{ kW}_n = 0.945 \text{ MW}_n$

% of  $P_p$  [peak power] /  $P_n$  [nominal power] =  $1178/945 = 1.246 \approx 124.6 \%$

To summarise this chapter, the table below establishes a comparison between different parameters for Energija and Lords projects.

<b>Project Dossier</b>	<b>Energija</b>	<b>Lords</b>
Inverters	Sungrow 125 kW <sub>n</sub>	Huawei 105 kW <sub>n</sub>
Optimisation of MPPs and in-between elements	Less optimised	More optimised
Strength of monitoring signal	Less strong (Modbus)	Stronger (PLC)
Cable type	DC cable is cheaper (2x unipolar)	AC cable is more expensive (1x 3-phase multipolar)
Concentration device	Tailor hand-made String Combiner Box (SCB)	Huawei's Built-in fused string inverter
Probability of fail	Higher (lots of fuses inside is handmade)	Lower (robust device by Huawei)
Damage in case of string overtension	Lower (SCB is a protecting element for the inverter)	Higher (no protecting element between strings and inverter).

*Image 39: Table with comparison of inverters' parameter for Energija and Lords dossier.*

Thanks the monitoring system we can easily detect which fuses and cables don't work. Every inverter has its own monitoring tracker. In local mode, as mentioned, Sungrow inverters work with the Sun Access mobile application, and Huawei inverters use Sun2000 mobile application. But in remote mode both of them are monitored by I+D Energias' own SCADA software, as explained in Chapter 2.6.

## 2.5. Weather station

The weather station system is the same for Energija and Lords projects, though it is connected to the Monitoring Box in the first case and to the Smartogger in the second one.

It consists of devices responsible for controlling weather conditions, for instance a pyranometer for measuring hemispherical total reflected light radiation, calibrated cell for measuring temperature and anemometer for measuring wind speed. These devices are connected to the monitoring rack.

The photo below shows the meteorological box with specific components to measure the weather parameters.

Inside the Weather Station boxes we can find the different communication components shown at Images 40 to 42, from which we can detach:

- Image 40: Meteo Box, Datalogger and Power Supply
- Image 41: Anemometer, Calibrated cell and Pyranometer
- Image 42: Ambient and Panel Temperature Sensors, placed at the back of the structure

And whose datasheets are available at Annex 2

- Datalogger – Programmable automation controller (PAC), NPE X500 is the series of industrial computers which you can easily adapt to your needs by choosing from the available options.
- Anemometer – ANEMO4403 V3 used for industrial need, e. g. in cranes, solar panels, buildings, wind turbines, weather stations connected to speed sensors such as tachometers, PLCs or data loggers to inform about the wind speed and set alarms.
- Calibrated cell – silicon sensors for measuring the solar irradiation. It provides a voltage proportionally to the intensity of the solar irradiation. The main functions are output and operational check of photovoltaic farms, controlling of shading equipment on buildings.
- Pyranometer – it is the smartest device to measure solar radiation. It consists of a low maintenance pyranometer with smart digital signal processing.
- 2 Temperature Sensors – for measuring the surfaces and the temperature of solar modules, and ambient temperature, respectively. We can measure temperature of the modules thanks to installing the surface temperature sensor at the solar module back. It is very important, because the efficiency of the photovoltaic module decreases by 0.43% when the module temperature increases.

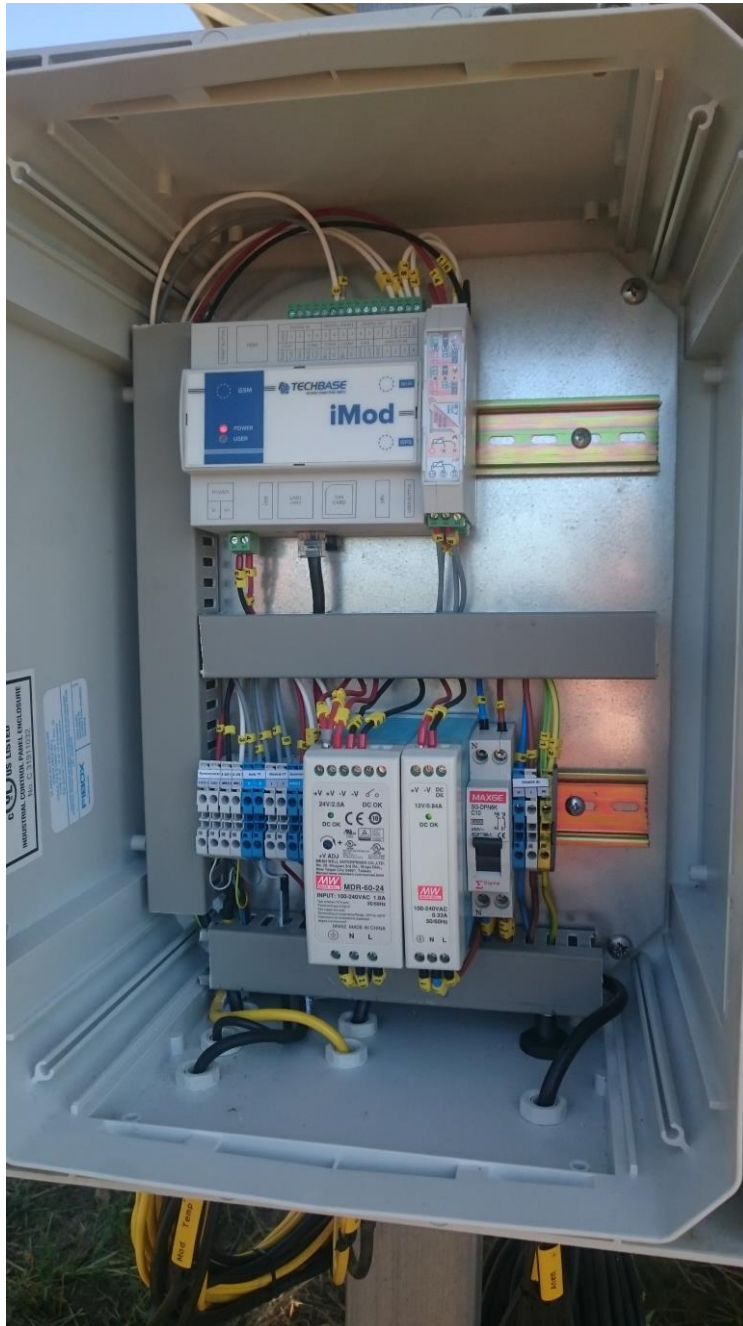
### 2.5.1. Student work for Weather Station: implementation and optimization of the system

The entire weather station has been implemented, optimized and adapted to work for the solar farm. Panel temperature sensors (for measuring solar panel temperature) and ambient temperature sensors (for measuring air temperature) at the back of the panel structure were installed.

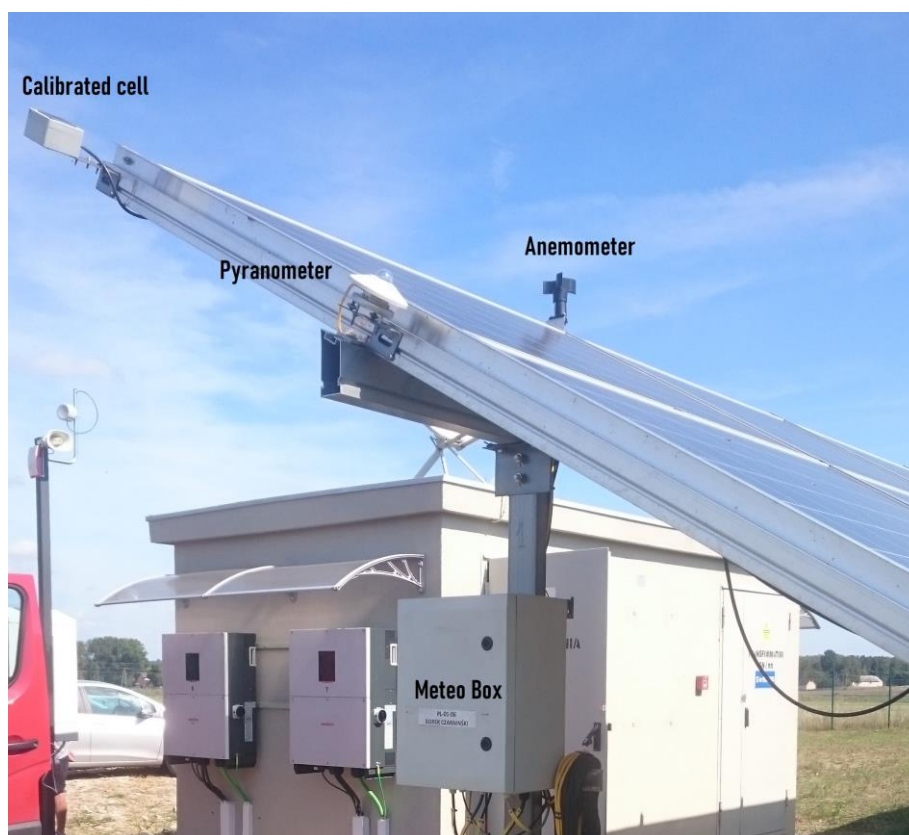
Moreover, Anemometer for measuring wind speed, Calibrated Cell for measuring temperature and Pyranometer for measuring hemispherical total reflected light radiation has been installed.

Communication tests (under laboratory conditions) between Meteo Box and Huawei's Smartlogger have been carried out, for Lords Project Dossier.

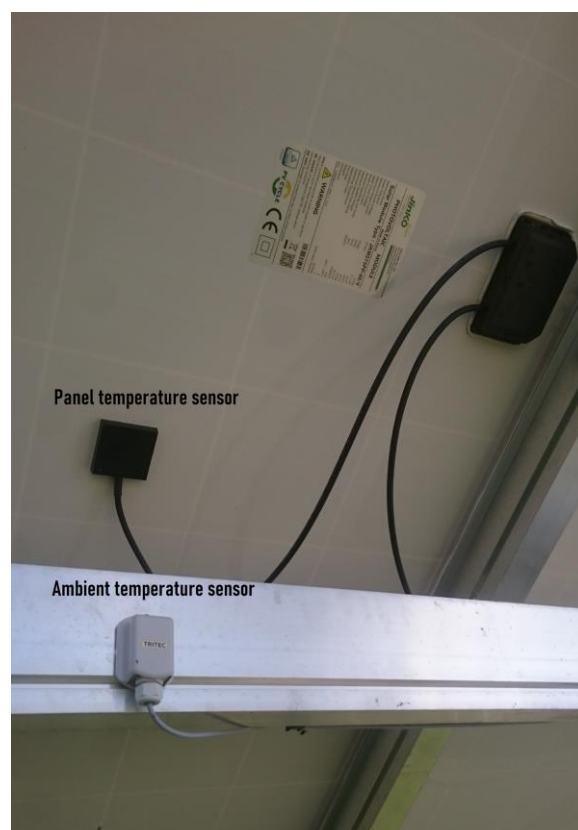
For Lords Porojects, after correctly connecting the Meteo Box to Huawei's Smartlogger, the Meteorological Box was located near Trafo station, connected with Datalogger and Power Supply. In the case of Energija Projects, the Meteo Box is connected to the Monitoring Box (because as already mentioned earlier for Energija we do not use Smartlogger).



***Image 40: Opened Meteorological Box with Datalogger and Power Supply. [own photo]***



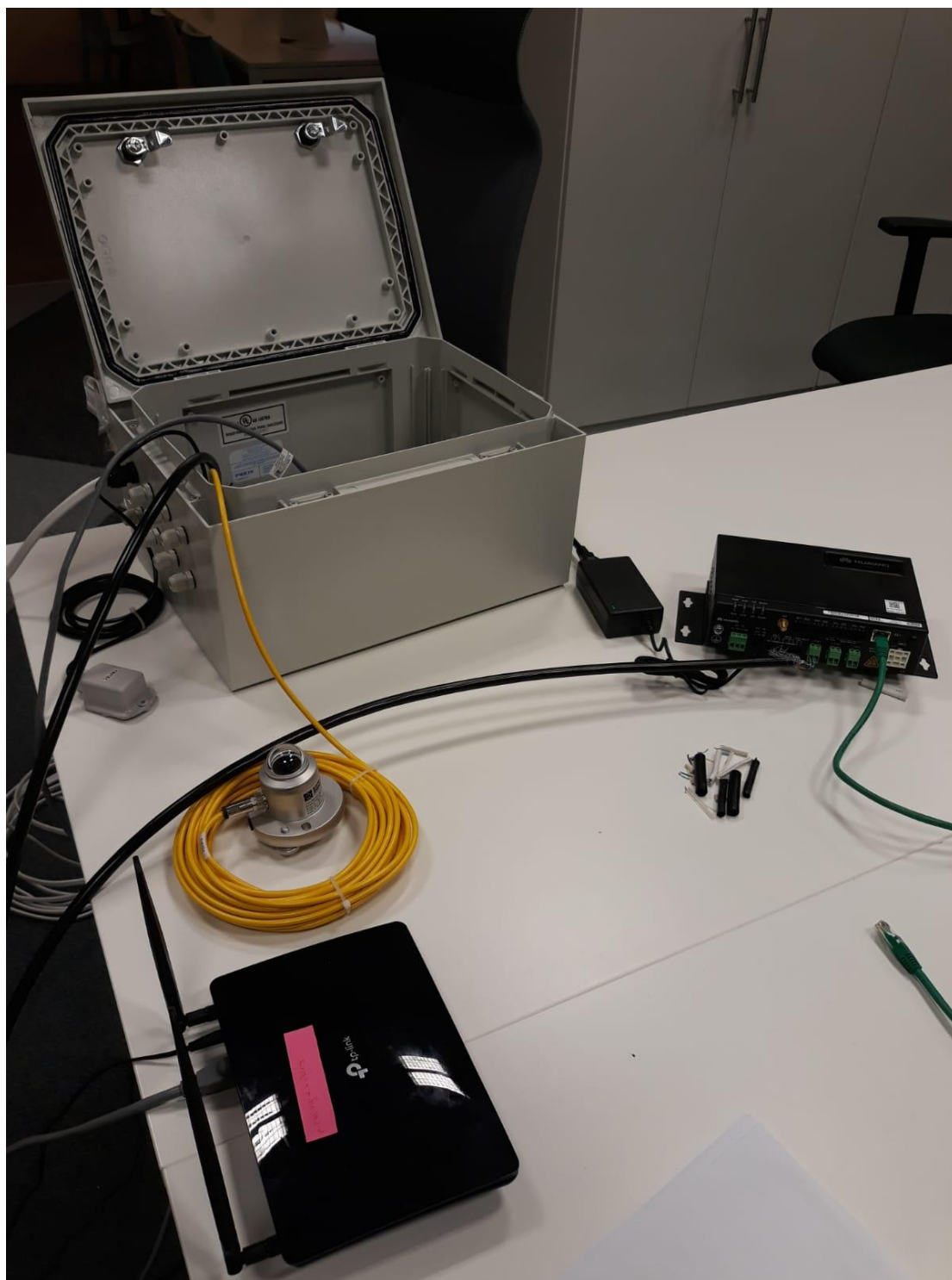
*Image 41: Weather Station composed of: Meteo Box (mounted as close as possible from Trafo Station), Anemometer, Calibrated Cell and Pyranometer. [own photo]*



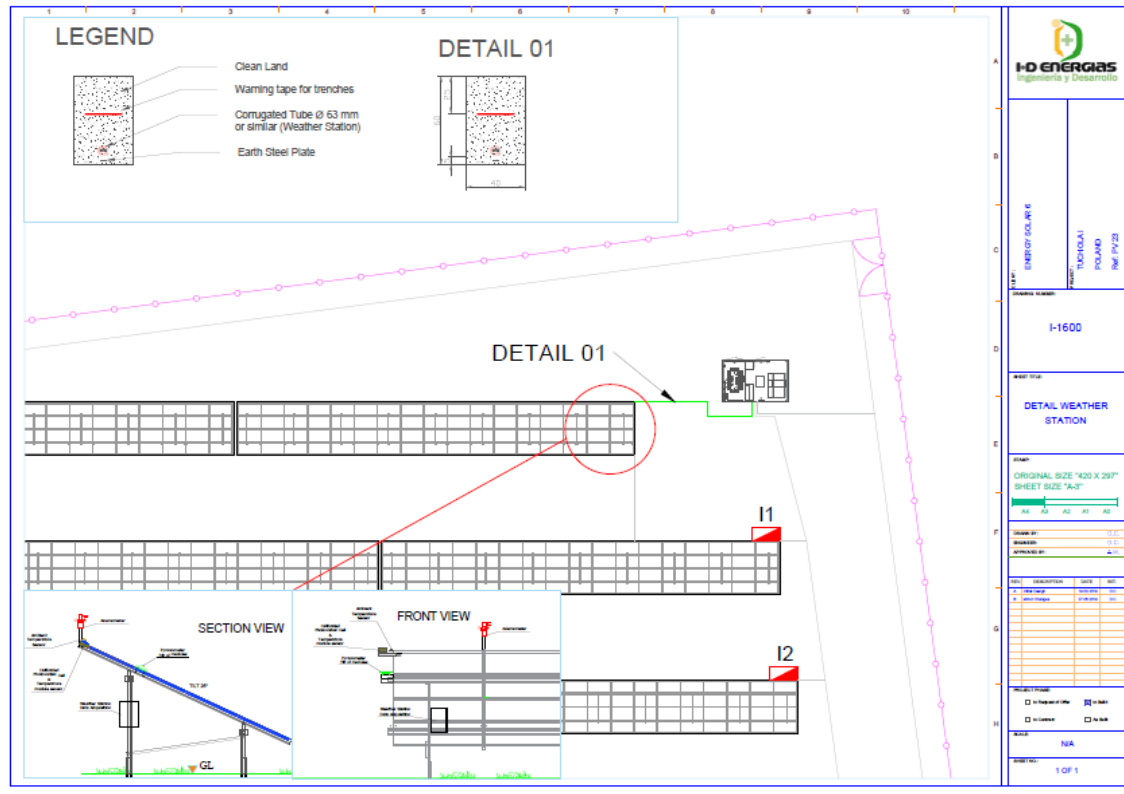
*Image 42: Ambient and Panel Temperature Sensors placed at the back of the structure. [own photo]*

The weather station is connected to the monitoring rack.

Photo below shows the connection tests (made at laboratory) between the Meteo Box and Huawei's smartlogger, made by the author.



*Image 43: Meteo Box connected to Huawei's Smartlogger. [own photo]*



*Image 44: Weather Station Layout. [company source]*

## 2.5.2. Bulleted conclusions list for Weather Station: implementation and optimization of the system

The weather station has been implemented, optimized and adapted to work for the solar farm. Panel temperature sensors and ambient temperature sensors at the back of the panel structure were installed.

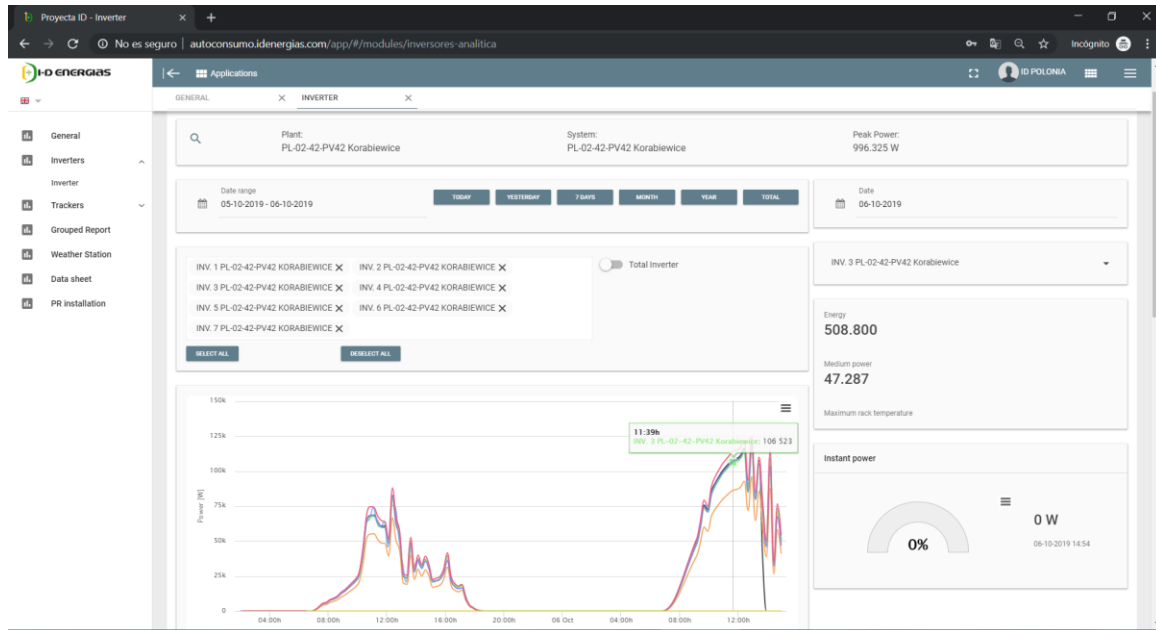
Anemometer for measuring wind speed, Calibrated Cell for measuring temperature and Pyranometer for measuring hemispherical total reflected light radiation has been installed.

Communication tests between Meteo Box and Huawei's Smartlogger have been carried out, for Lords Project Dossier.

For Lords Porjects, the Meteorological Box was located near Trafo station, connected with Datalogger and Power Supply. In the case of Energija Projects, the Meteo Box is connected to the Monitoring Box.

## 2.6. SCADA software

SCADA System is an IT software system supervising the technical process. The software is responsible for collecting current data, visualization, process control, alarming and data archiving. The Image below shows screen-friendly software presenting the inverters production. We note that the information from the Image shows Korabiewice photovoltaic farm. Data point out, including the energy produced, medium power, instant power.



*Image 45: Scada software screenshot. [own screenshot]*

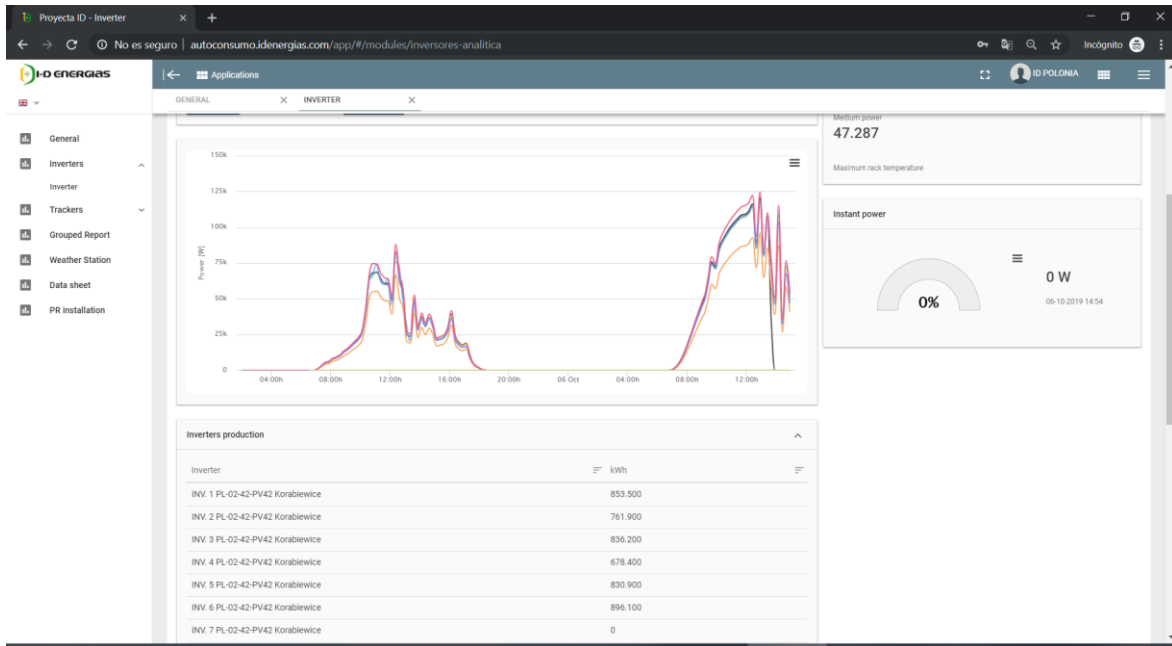
### 2.6.1. Student work: Inverters productivity and weather conditions analysis by SCADA software

The technical analysis of the inverter productivity, the weather station and the weather forecast, the power obtained by photovoltaic panels, the irradiation for solar farm, the ambient temperature and the panel temperature, the wind speed, was carried out using the SCADA programme.

Thanks to the program, we control all factors and data on an ongoing basis, and by analysing the data on the charts, we can react immediately if the data is not as expected. The graphs below present data for Korabiewice photovoltaic farm.

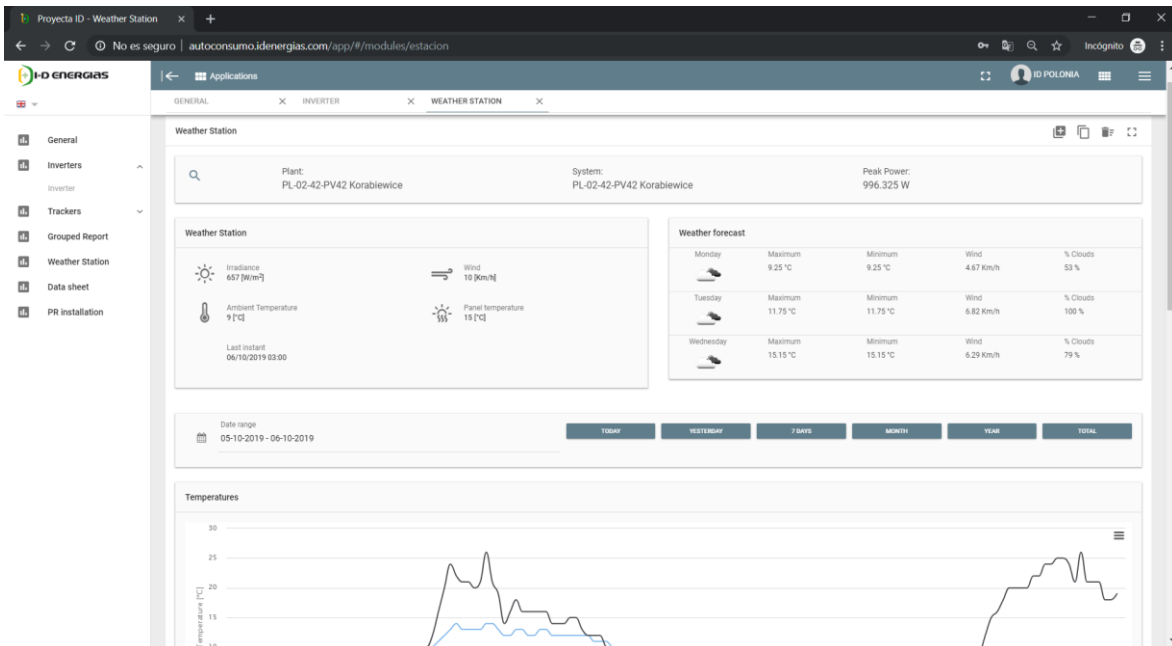
From this graph, we know how much energy photovoltaic panels generate during the day. We see that energy from Korabiewice solar farm is obtained between about 7 a.m. and 7 p.m., but we are able to calculate energy for the entire observation period.





**Image 46: Power plot from Korabiewice photovoltaic farm. [own screenshot]**

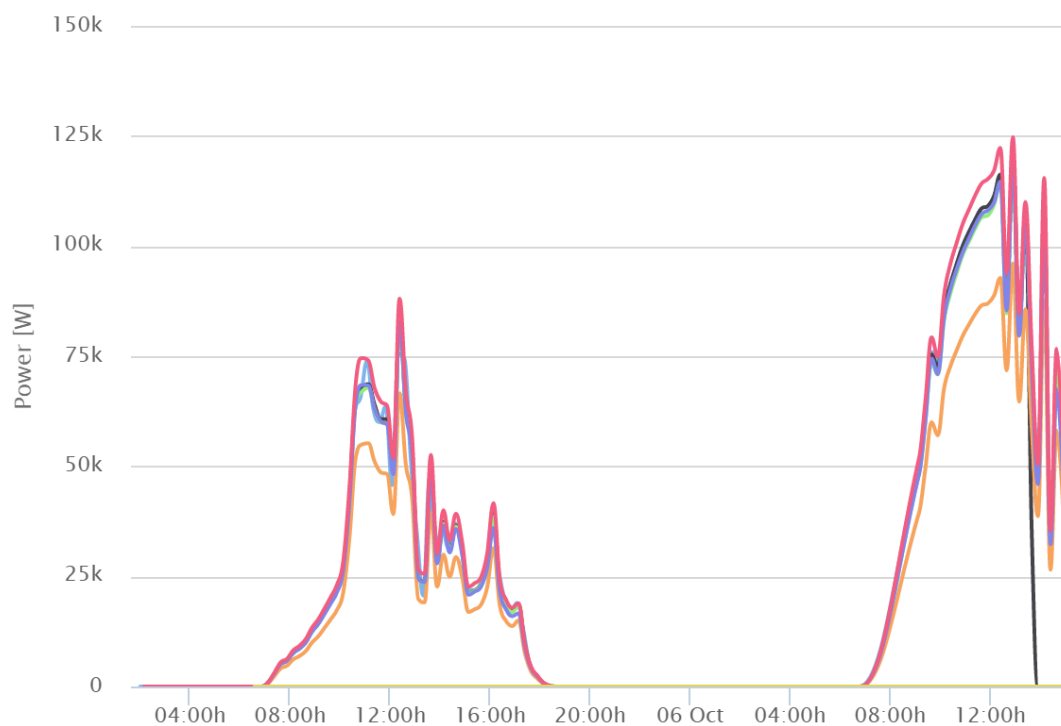
The SCADA software shows the current weather conditions as well as presents a weather forecast for the near future. The weather station included irradiance [ $W/m^2$ ], wind speed in [ $km/h$ ], ambient temperature [ $^{\circ}C$ ] and panel temperature [ $^{\circ}C$ ], whereas the weather forecast reports maximum and minimum temperature [ $^{\circ}C$ ], wind speed [ $km/h$ ] and a percentage of cloudiness [%].



**Image 47: Weather station and weather forecast for Korabiewice solar farm from Scada software. [own screenshot]**

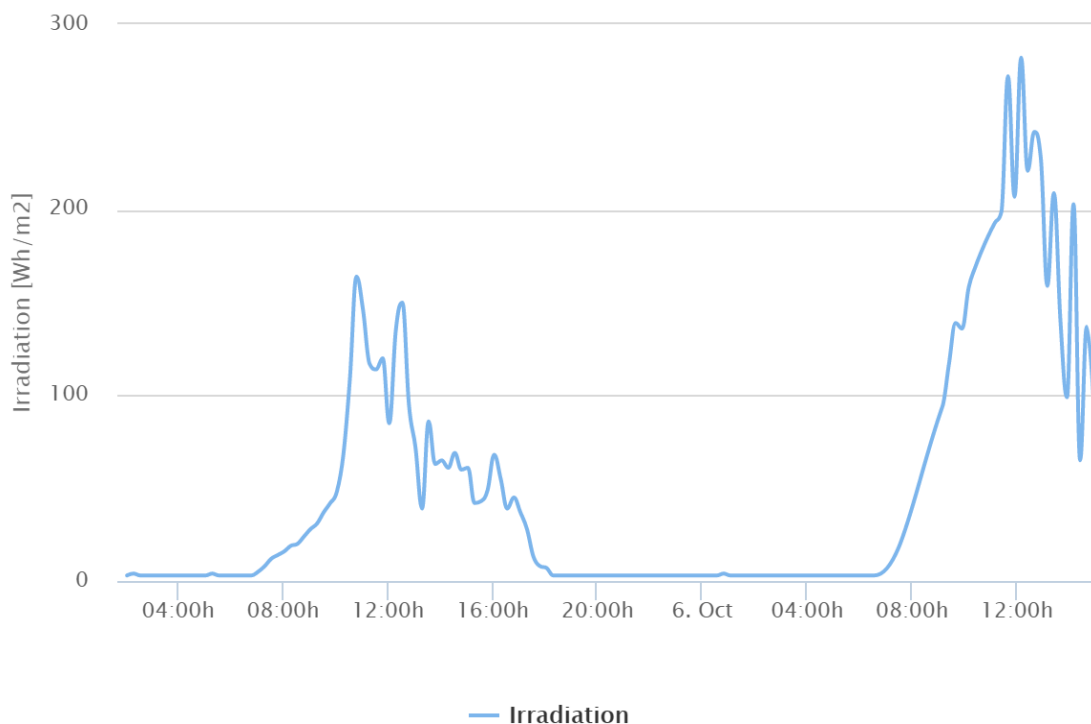
The charts present the data that was collected in one single day and analysed to check the quality and correctness of the entire implemented system on one of the farms.

The graph below shows power obtained by photovoltaic panels for a one single day.



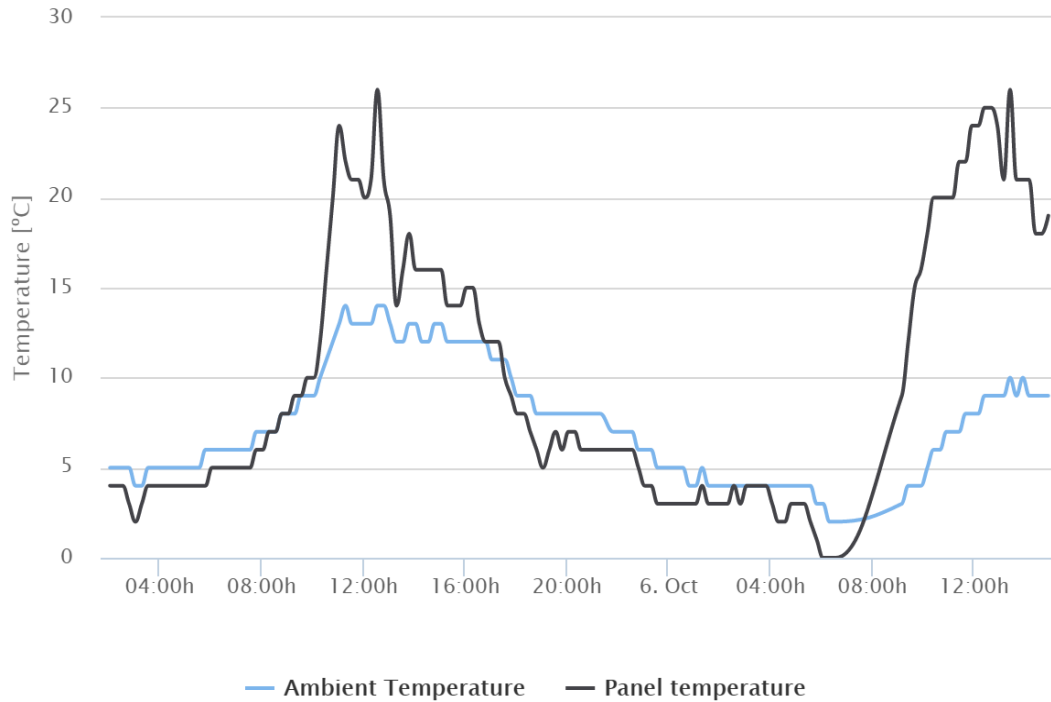
**Image 48: Power obtained by photovoltaic panels. [own screenshot]**

Here we observe irradiation for solar farm during a day.



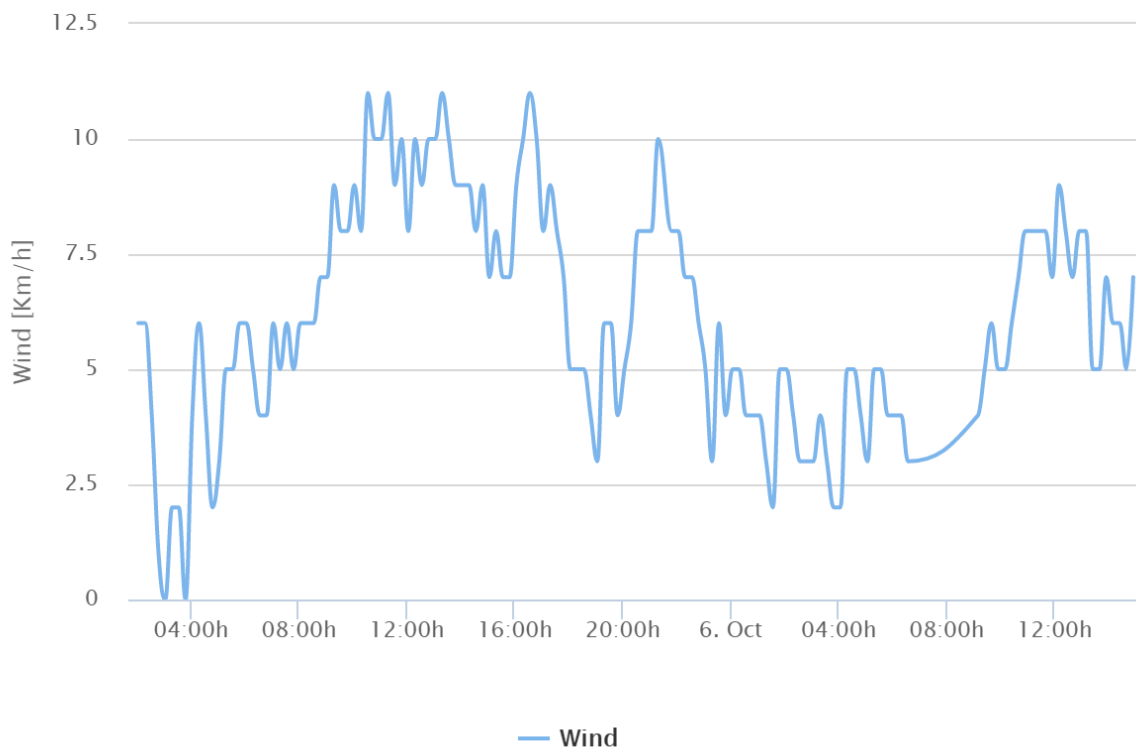
**Image 49: Irradiation for solar farm. [own screenshot]**

Comparison of ambient temperature and panel temperature we can observe on the graph below. We note that the panel is adequately higher than ambient temperature on the same solar farm.



**Image 50: Plot of ambient temperature and panel temperature. [own screenshot]**

Graph presents the wind speed for solar farm during one day. We can note when the wind speed was the strongest and when the speed of wind was the lowest.



**Image 51: Plot of the wind speed. [own screenshot]**

## 2.6.2. Bulleted conclusions list for Inverters productivity and weather conditions analysis by SCADA software

The technical analysis of the inverter productivity, the weather station and the weather forecast, the power obtained by photovoltaic panels, the irradiation for solar farm, the ambient temperature and the panel temperature, the wind speed, was carried out using the SCADA program.

All factors and data on an ongoing basis have been controlled. The data on the charts have been presented and analysed.

## 3. CCTV SYSTEM

### 3.1. CCTV Architecture

Closed Circuit Television (CCTV) is a system of monitoring places and objects using a camera system. The Image from the camera is sent directly to the surveillance center via cable and network. The person responsible for monitoring can use the special software to control what is happening on a given photovoltaic farm. CCTV is installed on solar farms to increase security and monitor environmental conditions at any time for a specific farm.

For the 1MW photovoltaic farm built by I+D Energias is standardly mounted 8 cameras. All the cameras must be connected to one of the 2 existing concentration points. First one is called primary node and is located inside the CCTV cabinet, next to the transformer station (shown at Images 53 to 56), and second one (secondary node or AC3CON) is at the most opposite pole from the primary one (shown at Images 57 to 59). In CCTV architecture, for both Energija and Lords portfolios, the company has used FTP cable for connections between cameras directly to their connecting point (primary or secondary), because the distance between both is not so long to disturb cameras system work and the information can be correctly transmitted. However, for the connection between both concentration points, a fiber optic cable is needed, due to the fact that the in-between distance form is long enough to require fiber optics to guarantee a lossless transmission.

The Image next shows one example of CCTV layout for a photovoltaic farm. Every CCTV camera is located on one pole, so every camera is watching next one, forming a ring. The observation fields have the form of a circular sector, with the vertex located on the camera position. This distribution is necessary for videoanalytics purposes, and the distance between cameras also depends on the required resolution for videoanalytics.

Basic rules for videoanalytics are explained at the end of this chapter.

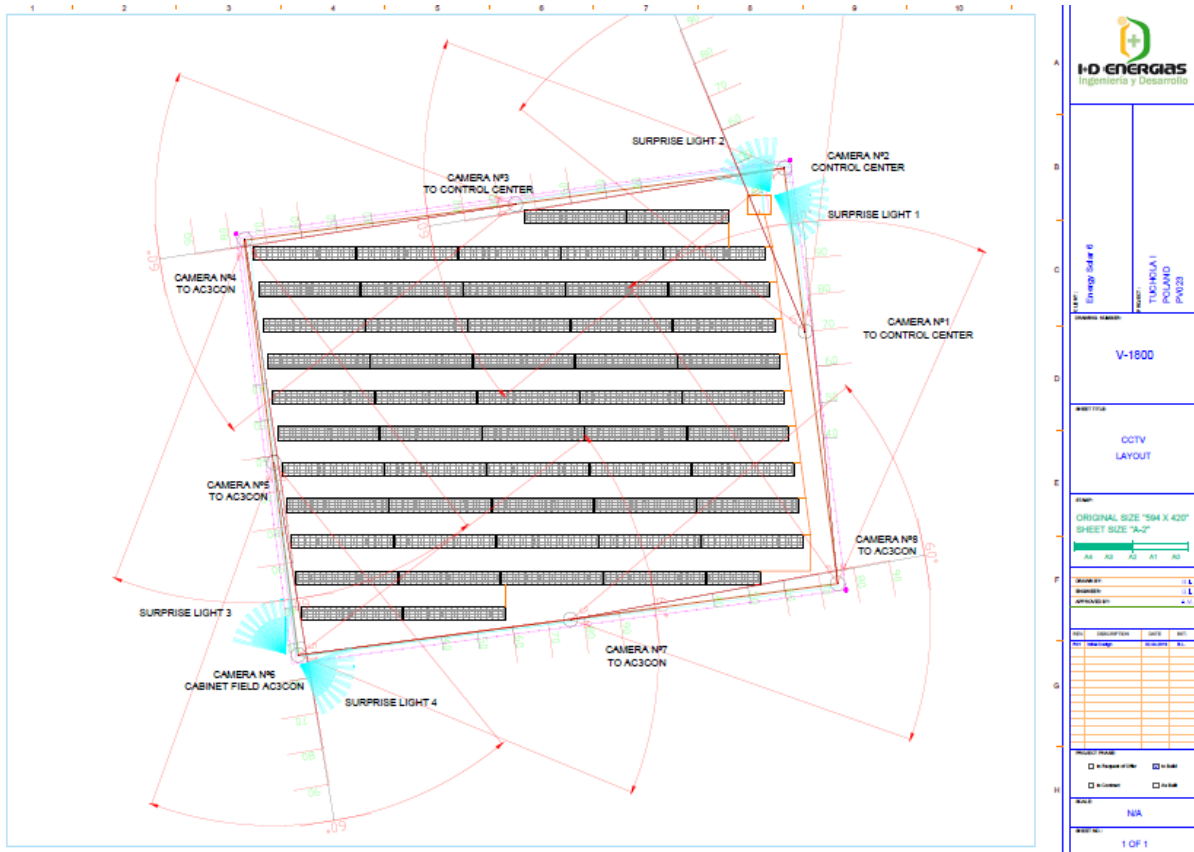


Image 52: CCTV layout for photovoltaic farm. [company source]

### 3.1.1. Student work for CCTV System Architecture: construction, optimization and run the system

We have introduced changes to the CCTV System architecture design. For a large solar farm area it was difficult to connect all cameras via FTP cable because the camera image was losing quality. Therefore, in these projects 2 concentration points were used, which collect the image from other cameras (by FTP cables) located near these points. However, the combination of these 2 concentration points was made of fiber optics. Thanks to the solution we have used in these projects, we can collect data from cameras without loss of information.

In addition, cameras were installed in CCTV System architecture so that the lens of one camera in the field of view has a second camera, the second camera sees the third. The cameras are arranged in such a way as to form a ring.

Below each camera mounted on a pole, an infrared lamp was installed (at an optimal distance from the camera to prevent night butterflies from entering the camera's eye and acting as light scatterers) to ensure better visibility for the camera at night.

To build the entire CCTV system, the trenches were carefully dug and cables were laid in appropriate security pipes.

Finally, the appropriate cables were led out and connected to cameras and CCTV cabinet, after installing all components inside the CCTV cabinet, it was secured.

After all the work related to the installation of the system on the side, technical inspection of the system was carried out, cameras were analysed and optimized.

The photo below shows CCTV cabinet next to transformer station mounted in Energija's projects. This solution provides more space inside the transformer station and renders CCTV cabinet more available.



*Image 53: CCTV cabinet next to a transformer station, at right side of the picture.  
[own photo]*





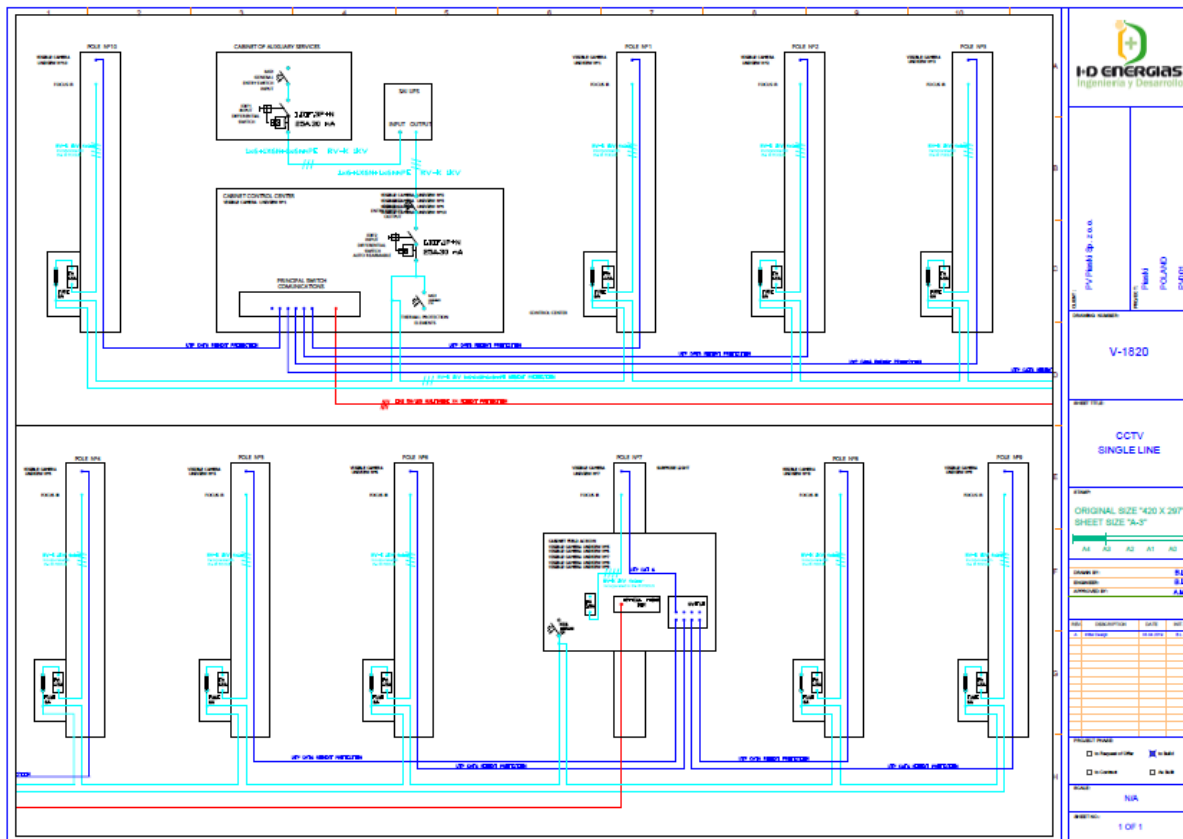


Image 56: CCTV single line. [company source]



Image 57: CCTV AC3CON box. [company source]



Image 58: CCTV AC3CON interior. [own photo]

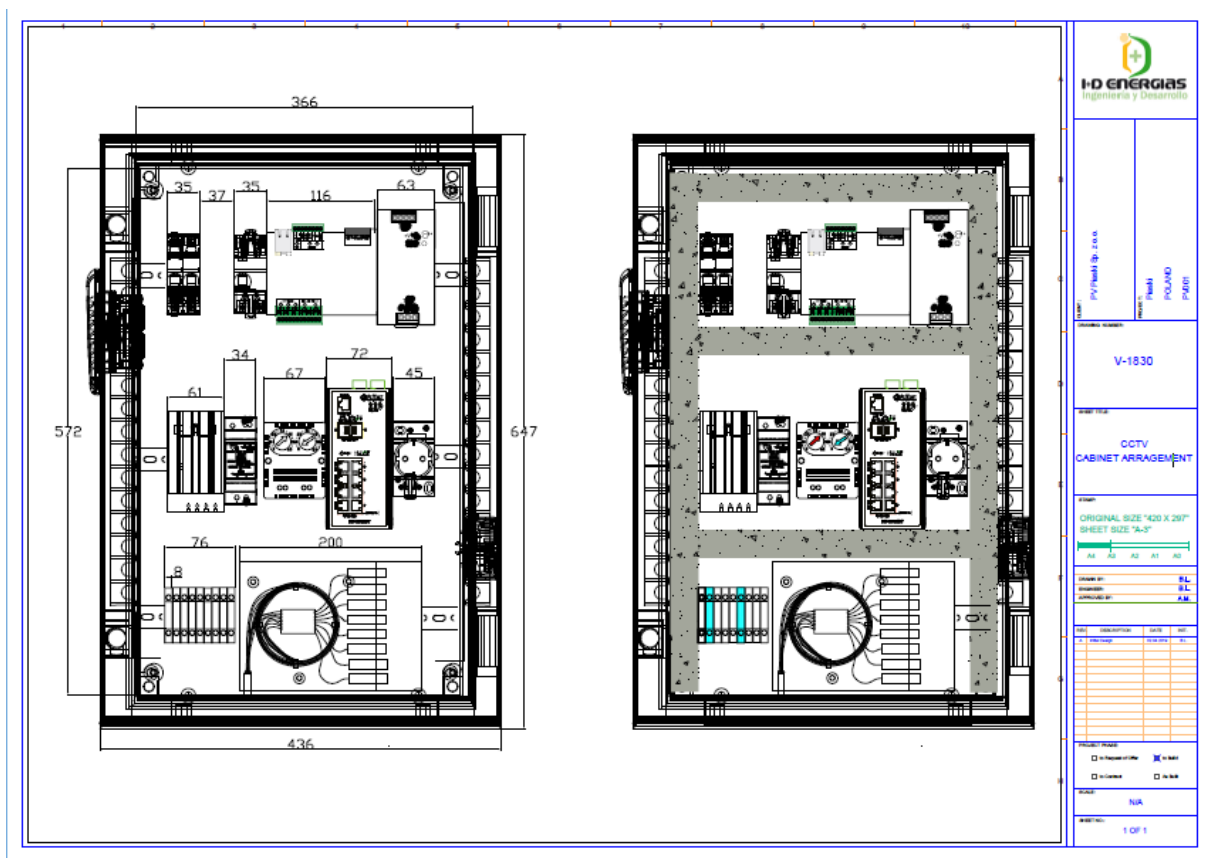


Image 59: CCTV AC3CON connection. [company source]



*Image 60: CCTV camera and AC3CON mounted on a pole. We can observe specific IR lamp mounted below the camera to help get better image of the camera during the night.  
[own photo]*

The Image below shows CCTV foundation work. The cabling is responsible for transfer information from camera.

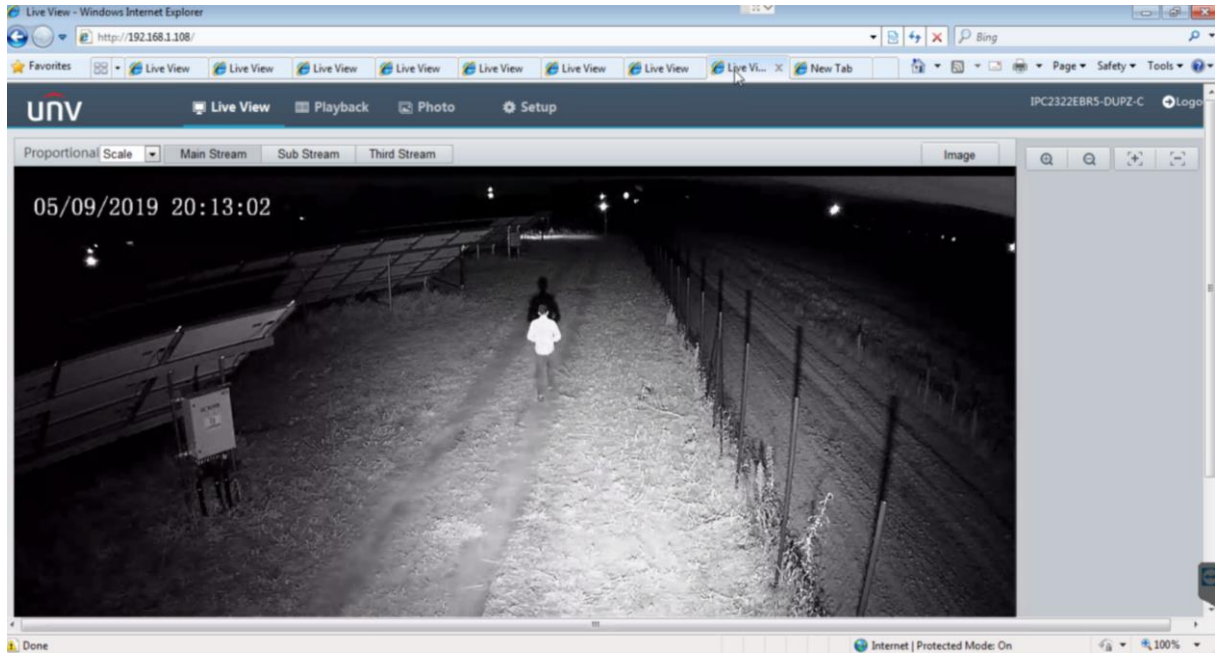


***Image 61: CCTV foundation works. [own photo]***



***Image 62: Pole with cabling and a manhole after foundation works. [own photo]***

In the Image form camera view we can observe the area and the path next to the fence. Thanks to a dedicated software we are able to control what happens on a farm at any time of the day from anywhere in the world.



*Image 63: Camera Image for one of the photovoltaic farm. [own screenshot]*

### 3.1.2. Bulleted conclusions list for CCTV System Architecture: construction, optimization and run the system

We have introduced changes to the CCTV System architecture design. In these projects 2 concentration points were used, which collect the image from other cameras (by FTP cables) located near these points. The link between these 2 concentration points is made of fiber optic. Thanks to this solution, the data from cameras are collected without loss of information.

Cameras were installed in CCTV System architecture so that the lens of one camera in the field of view has a second camera, the second camera sees the third. The cameras are arranged in such a way as to form a circle.

Below each camera mounted on a pole, an infrared lamp was installed to ensure better visibility for the camera at night.

The trenches were carefully dug and cables were laid in appropriate security pipes.

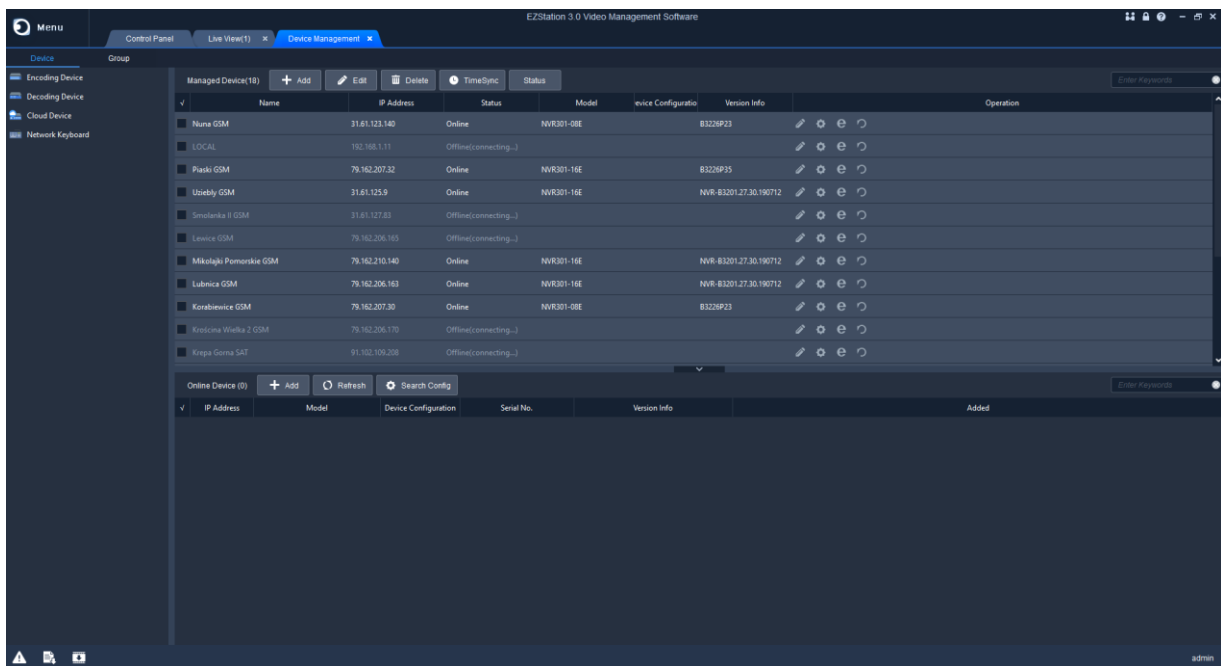
The appropriate cables were led out and connected to cameras and CCTV cabinet, after installing all components inside the CCTV cabinet, it was secured.

Technical inspection of the system was carried out, cameras' work were analysed and optimized.

## 3.2. Supervision and monitoring optimization by student in the EZStation software

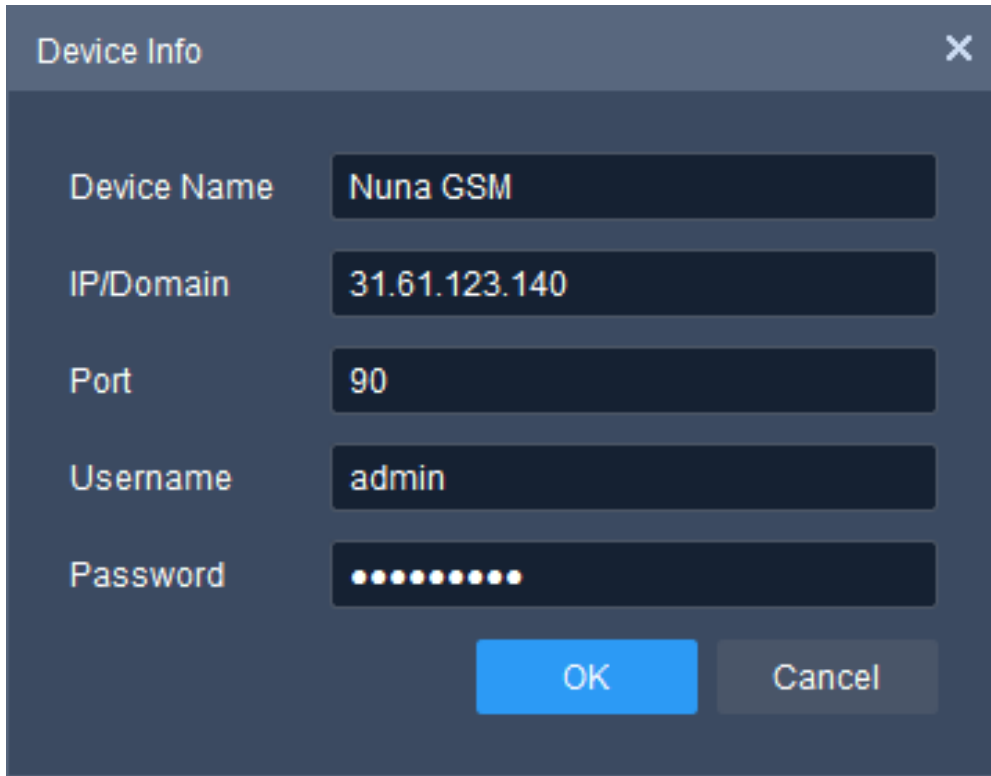
EZStation is the video management software helping supervise and monitor the operations of cameras on the photovoltaic farm. It is an Uniview's proprietary software, so the full compatibility between hardware and software is guaranteed.

All the solar farms have been added to the database in the programme and optimized. Each solar farm has its own name and access code by having its own IP addressing, on the following images we can see Nuna fotovoltaic farm. The image view from each camera was checked, the camera view was adjusted to best reflect the real situation on the solar farm.



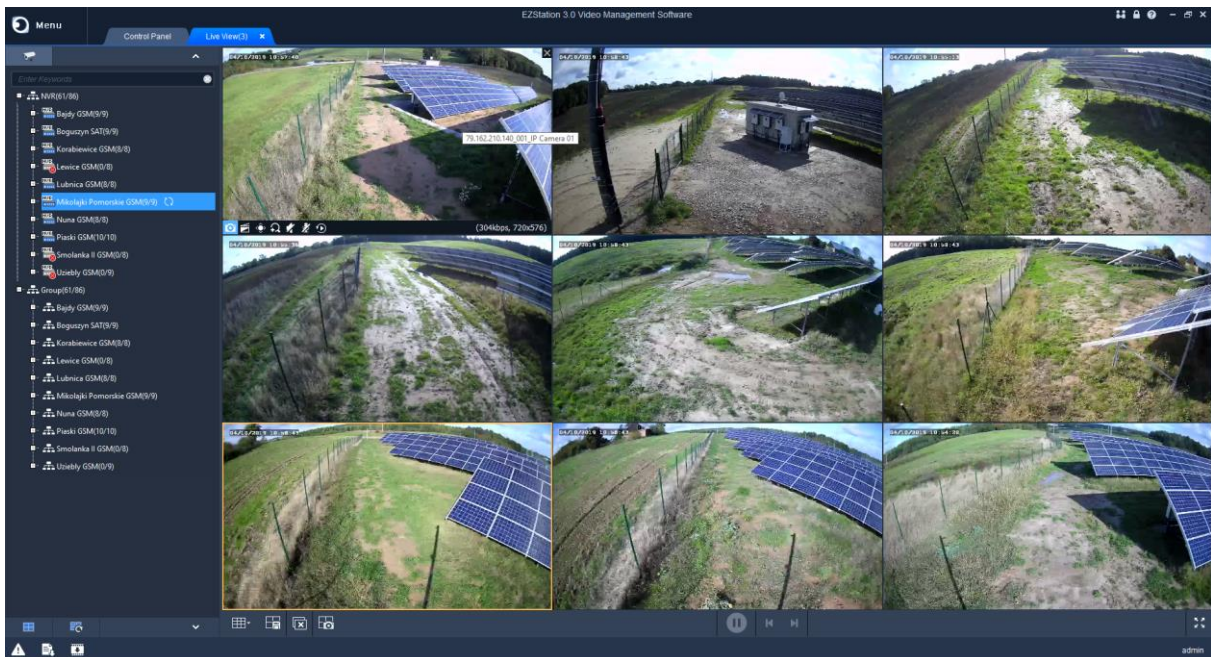
*Image 64: List of photovoltaic farm operated by EZStation software. [own screenshot]*

EZStation software is personalized and dedicated to particular areas of observation. In the Image below we see the operating window for Nuna photovoltaic farm.

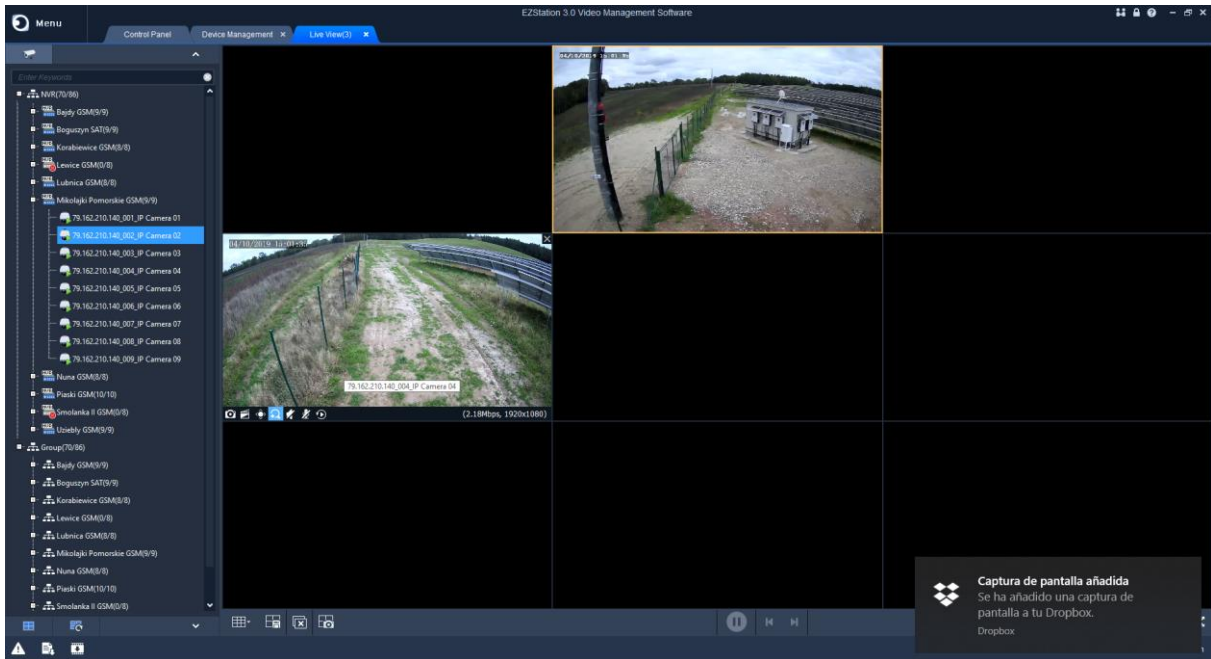


*Image 65: Operating window for Nuna GSM. [own screenshot]*

Here we observe Images for all cameras for Nuna solar farm. Since there are more than 9 cameras, we need a second screen to show the last ones.



*Image 66: View from all cameras installed for the Nuna photovoltaic farm – part1. [own screenshot]*



*Image 67: View from all cameras installed for the Nuna photovoltaic farm – part2. [own screenshot]*

EZStation allows us to make a zoom view to have more detailed resolution, as shown next.



*Image 68: View from one of cameras for the Nuna photovoltaic farm. [own screenshot]*



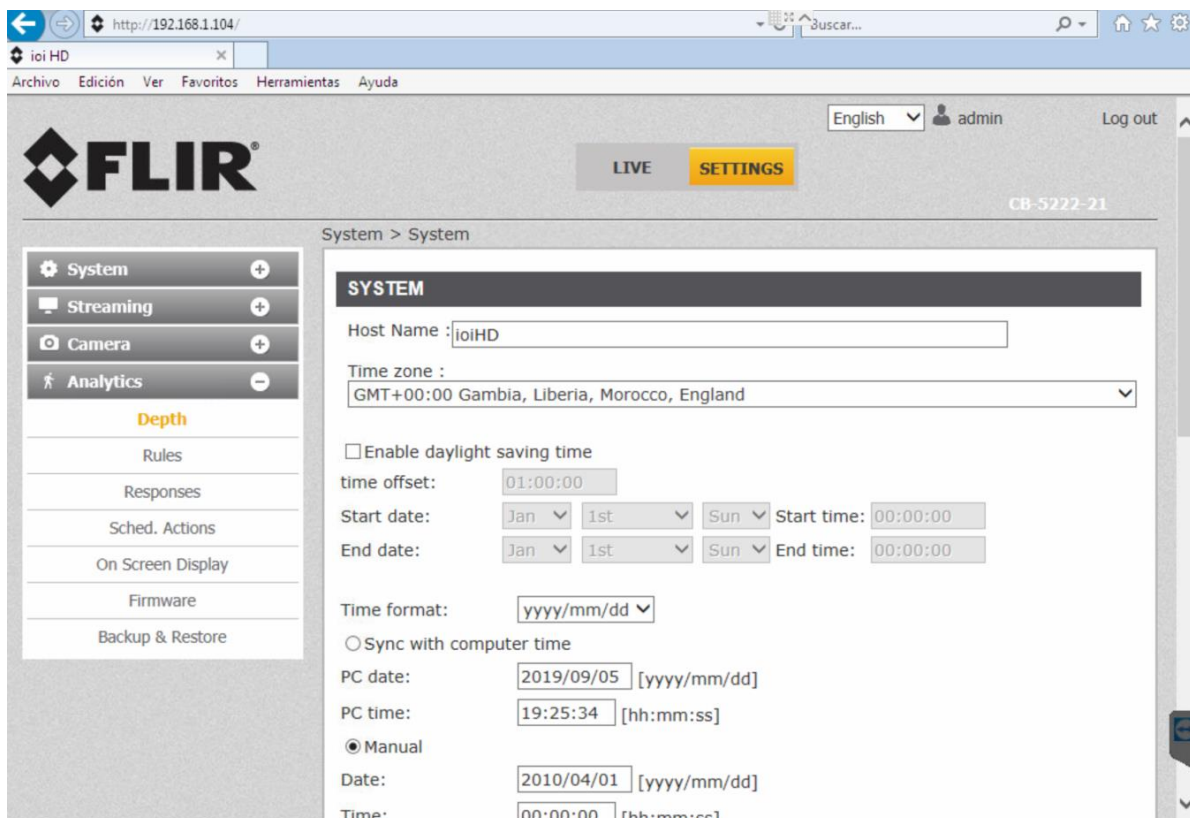
### 3.3. Video analytics and FLIR System

When the technology was not as developed as at present time, the CCTV systems in general used to work under the simple observation of the screen monitoring. Nowadays, as described in [6], Video analytics is now the Big Focus in CCTV Surveillance, even more if we must control so many installations at once in real time.

The advantages are clear: Time and money savings because less video information is sent over the network, reducing network load and storage needs, and higher efficiency because we can count with different scenario patterns depending on weather conditions, height of vegetation, existing local fauna, etc.

I+D Energías works, for the CCTV Video analytics, by using a software developed by the manufacturer Flir [7], that can be used for own Flir devices and also compatible ones from other manufacturers, as Uniview, the one used for these projects in Poland.

As shown in Image 69, Flir’s Video analytics System works under a web browser, given that the cameras are IP-based technology. At left-hand menu, we can select the different parameters for the video analytics: Depth, Rules, Responses and Scheduled Actions.



**Image 69: Flir’s Video analytics System with the changing parameters: Depth, Rules, Responses and Scheduled Actions. [own screenshot]**

As described in [7], these patterns establish the usual scenarios for potential intruders: height (an animal should not be detected as a human), trajectory run by the potential intruder (a person would cross the fence and walk in a straight way), and behaviour (probably trying to

be hidden from the cameras by the structures, whilst an animal would not behave this way), etc.

### 3.3.1. Student work for Video analytics and FLIR System

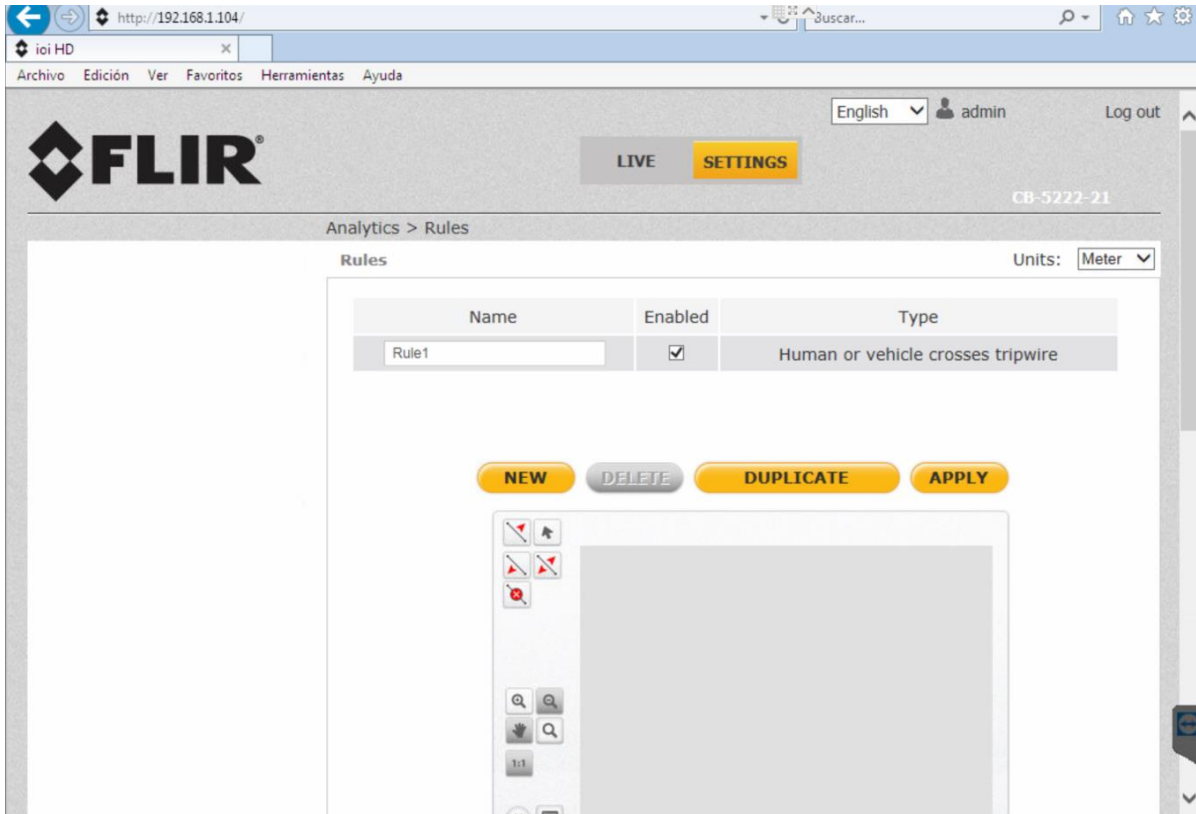
FLIR software is another program that was used to supervise and monitor a solar farm. Safety and protection of such an expensive and modern investment as a solar farm is the supreme value for the company. That is why reliable and precise Uniview cameras were installed and the Video analytics system was implemented.

Each camera has been optimized using FLIR software for even better protection and increased system productivity. Attention was paid to weather conditions prevailing in a given climate zone, and based on this an analysis was carried out.

A very important factor was the analysis of fauna and flora occurring in a given region, because all these factors affect the image that the camera eye perceives. This can cause false alarms, weaken the control system, and eventually lead to the unnoticed intrusion of the thief into the solar farm. Which can result in farm destruction or theft of expensive installations.

In fear of this, each camera has been checked and programmed to work as well as possible. Camera parameters have been set to exclude false alarms, e.g. movement around the solar farm area of small rodents such as mice.

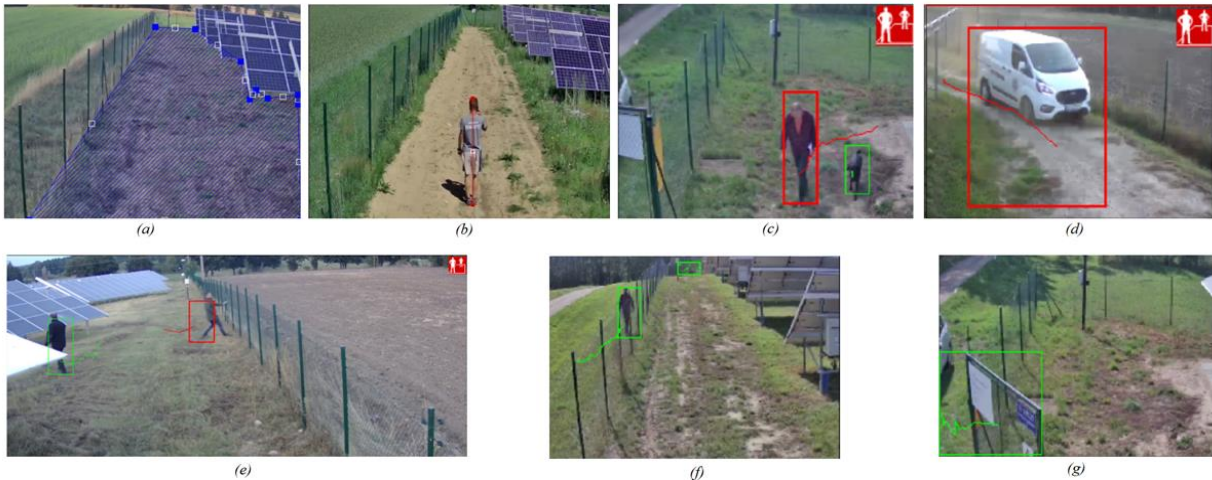
In winter and during heavy rainfall, when puddles appear, the camera image can be illegible or even completely invisible, by the reflection of sunlight from the surface of snow or puddle, towards the camera eye. To prevent such situations, we have reduced the camera's sensitivity to light. The camera parameters have been set accordingly to avoid camera interference.



**Image 70: Screenshot of Analytics Configuring: [own screenshot]**

It is not the objective of this thesis to deepen the different configurable rules of video analytics, but to show the reader that a large number of configurable parameters are available. We can highlight the following ones:

- *Depth tab* enables CCTV system administrator define the perspective of the scene being monitored (3D view). Depth can be calibrated automatically or manually. Image 70 (a) shows the definition of a multi-segment fence.
- *Detection rules* are a combination of one or more conditions that must be met in order to register an intruder detection (and therefore, an alarm is generated), whilst a friendly or non-intruder detection would not generate any kind of alarm. Detection rules in a defined region include: Region entrance, Loitering, Tripwire Crossover, Fence Trespassing, Stopped Vehicle and Object Removal. Image 70 (c) to (g) shows different situations of intruder and non-intruder's detection.
- *Responses* and *Sched. Actions* screens are similar, and they include the following elements: *Triggering Events* (Definition of the type of event which will start the automatic response), *Actions* (Definition of the actions to be performed on the occurrence of a triggering event), and *Schedule* (When configuring automatic responses, this option enables CCTV system administrator to define when to monitor for the triggering event occurrence).



**Image 71: Definition of intrusion area (a) and intruder's height (b) in Flir's Video analytics System. Human (red) and Animal detection (green) (c). Vehicle detection (d). Non-intruder (left, green) and Intruder detection (right, red) (e). Non-intruder, walking outside the fence (green) (f). Object movement (gate being swung by the wind) (green) (g). Source: I+D Energías's proprietary production.**

We want to show not only the complexity of the video analytics system (with a very extensive number of rules to be defined for each scenario), but also the need to make an effective and dynamics re-configuring of these rules, not only to fine-tune the system effectiveness, but also to make it adaptive to the numerous context variations.

In this way, a high vegetation or tree crowns, linked to a homogeneous wind speed, may be understood by Video analytics as a straight trajectory run by an intruder (equivalent height), creating a fake alarm. Besides, if the terrain is wet or snowed, the cameras may receive reflections since the terrain can act as a mirror, creating also fake alarms. And at night, for a more efficient operation of the system at night we use special lamps with infrared light and ordinary lamps with white light, whose operating times can only be set according to our preferences. But the appearance of night insects flying around the lamp may also create fake alarms into the camera because they act as light scatterers.

In conclusion, thanks to Video analytics and Flir's software we can dynamically control the parameters of cameras and sensors from every corner of the world. As described, we can adapt them to the different patterns, to reduce the number fake alarms. But these patterns and parameters must be set manually by a CCTV operator or administrator because, with the existing technology, the human criteria is the only way to have a clear idea of what must be changed.

In this sense, it is very important to emphasize the fact that changing one camera parameter requires mouse moving, clicking many buttons, opening or the closing of the different screens and takes a lot of time, even more for a scattered PV generator composed of 43 or 66 solar farms. So, what happens if a lot of parameters must be changed, after the observation and decision made by the operator, with a lag of about 800 ms? Flir's software management can be eternal for the operator with such a high latency time. So, at the end, these patterns are very rarely remotely changed if we run under Satellite Systems, and therefore the power and effectiveness of Video analytics is reduced because of lag time of Satellite option. Once again, it is important to emphasize that we must control quite a lot of solar farms at once in real time.

### 3.3.2. Bulleted conclusions list for Video analytics and FLIR System

The reliable and precise Uniview cameras were installed and the Video analytics system was implemented. Each camera has been checked and programmed to work as well as possible.

Cameras have been optimized using FLIR software for even better protection and increased system productivity. Attention was paid to weather conditions prevailing in a given climate zone, and based on this an analysis was carried out.

The camera parameters have been set accordingly to avoid camera interference, false alarms, sunlight reflection.

## 4. GATEWAY TO THE INTERNET

### 4.1. 4G Network in Poland

In parallel with the evolution of solar photovoltaics, is also a fact that the 4G network in Poland has experienced a spectacular growth for what concerns to rural areas (where the solar farms are installed), making possible a global solution for the vast majority of Polish territory [8].

Image 72 shows the 4G coverage map for the operator Play, the one with a more complete one, in September 2019.



*Image 72: Map of 4G network coverage for Play operator in Poland. Source: [9]*

4G network, in case of a proper coverage, can be a good option for the communication needs of the solar farms, because they need a good, fast and reliable network connectivity to control and monitor CCTV Images, production control, atmospheric changes (through the weather station that is also installed to monitor weather parameters), security systems and in general all the data needed for the operation of a solar farm.

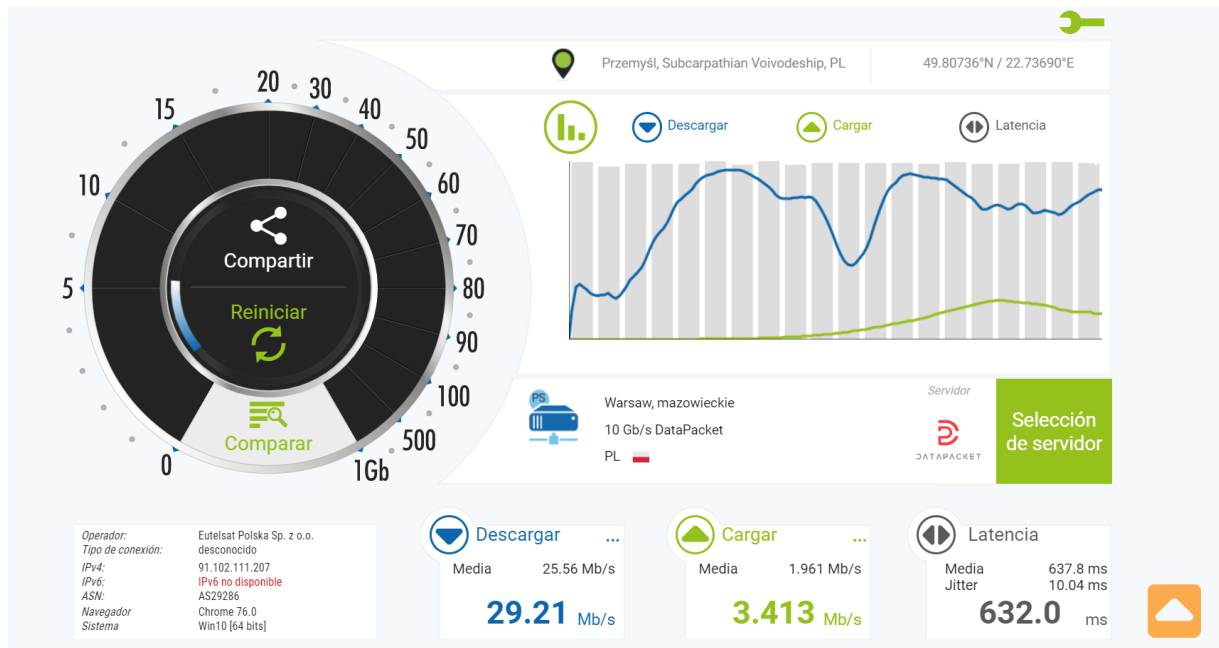
The problem is that, during the construction of the first solar farms of Energija portfolio, at the second quarter of 2018, 4G network quality on these sites was still poor, and in some cases even non-existent, so 4G option was dismissed for this portfolio and I+D Energías had to choose a Ka-satellite communication system, as described at the next part of this thesis.

## 4.2. Student work for Energija Dossier: Global Satellite Solution

The satellite signal for the location of a given solar farm was analysed in order to select the most optimal solution for communicational needs on the farm. After research, it was decided which satellite antenna (dish) would be the best solution.

The next step was to assemble the antenna and place it on the roof of the transformer station. It was very important to properly point the antenna towards the satellite, at the right angle.

Finally, the rack and the antenna were connected to the satellite modem located in the monitoring cabinet in Trafo station.



**Image 73: Software screenshot with latency results for satellite [own screenshot]**

This Ka-satellite communication system, is composed of Satellite Antenna + LNB, Satellite Modem, Uninterruptible Power Supply and Router, as shown in Images 74 and 76. Its provider is Skylogic, a company belonging to the European carrier Eutelsat



***Image 74: Satellite Modem and Router already connected to the monitoring cabinet, inside transformer station. [own photo]***





*Image 75: Satellite Antenna mounted on the top of the transformer station. [own photo]*



*Image 76: Satellite antenna with rack and cabling. [own photo]*

Satellite solutions are universal, but unfortunately quite expensive and they have a high latency time that comes to be around 800 ms and even above. The transmission speed is very asymmetrical depending on the direction: 30 Mb/s for the downlink (reduced to 0.5 Mb/s when the 25 GB monthly quota is consumed) and 3 Mb/s for the uplink.

Concerning lag time, for a continuous data flow in one direction, mainly the uplink because the information is sent from the solar farm to the remote controlling user and not reverse, this is not a problem (the information just reaches the destination 800 ms later), but if we need to remotely interact with the communication systems, as explained in next chapter, the lag times make the procedure very ineffective and tiresome. This effect is even worse when we need to control a lot of scattered installations, as it happens at these project portfolios developed in Poland. In fact, every 1 MW solar farm must count with its own communication system, making the remote control more difficult than for a non-scattered PV generator, as it can be a single solar farm, on the order of several tens of megawatts, but with a single communications system to control it entirely.

Another advantage of satellite systems with respect of 4G option is that satellite is in fact a dedicated link (point-to-point solution), with no usual competence with more users that can be suddenly present in the area of the corresponding base station, competing for the available channels and their bandwidth.

### 4.2.1. Bulleted conclusions list for Energija Dossier: Global Satellite Solution

The satellite signal for the location of a given solar farm was analysed in order to select the most optimal solution for communicational needs on the farm.

The satellite antenna (dish) have been assembled, installed and placed on the roof of the transformer station. It was very important to properly orient the antenna towards the satellite, at the right angle.

The rack and the antenna were connected to the satellite modem located in the monitoring cabinet in Trafo station.

### 4.3. Student work for Lords Dossier: Migration to 4G

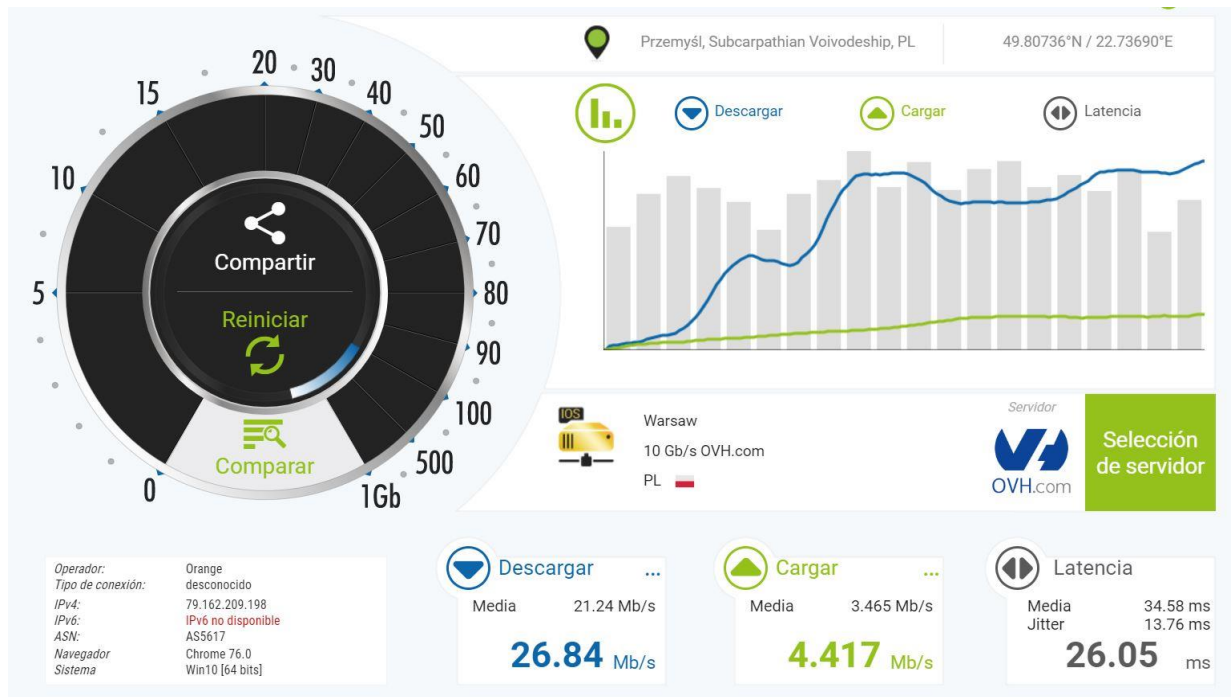
As mentioned earlier, in Poland, connectivity via 4G network has improved significantly and began to meet the communicational needs for solar farms, which is why the latest Lords Project Dossier decided to transfer all responsibility for connectivity to 4G networks.

However, for each region in Poland, the intensity of the 4G network is different and not always sufficient, which is why the quality of 4G network coverage has been checked for each project.

If the 4G signal was sufficient, the target solution for Lords Projects was implemented. A 4G network router was installed and installed, the receiver was configured with the network and the system was checked.

To amplify the 4G signal, a 10-dBi Mikrotik antenna directive was installed.

However, if even after the Mikrotik antenna was mounted, the 4G network signal was insufficient, unfortunately it was necessary to test for satellite connectivity and mount the satellite antenna. But this option is the final solution.



**Image 77: Software screenshot with latency results for 4G. [own screenshot]**

To increase the efficiency of the Video analytics, and to enable the system operator to change its patterns and parameters, we must quit satellite option for communications. We must therefore try 4G system.

When Lords dossier started in July 2019, several field tests were made in order to verify if 4G option was suitable. The results were quite satisfactory and the solar farms belonging to this dossier are running on a highly directive 4G Mikrotik antenna, model SXT-2 10dbi, 60 degree, integrated AP/Backbone/CPE, dual chain, Gigabit Ethernet (Image 78) [10], with a SIM card, instead of a satellite system.

From the economic and technical points of view, 4G is a cheaper solution with a tiny lag time. However, if there are many network users in the coverage area, the range may drop to 3G or even 2G, and even the signal can be completely lost. This phenomenon can have a negative impact on the functioning of all systems on the farm, responsible for its proper functioning.



*Image 78: 10-dBi directive Mikrotik antenna to increase. [own photo]*

It is important to highlight that a few Lords projects are running on satellite, because we cannot find a correct 4G network coverage alternative with any Polish 4G operator. But this can be considered the least bad option, since it can never be as tiresome as running all the projects under satellite link.

### 4.3.1. Bulleted conclusions list for Lords Dossier: Migration to 4G

The quality of 4G network coverage has been checked for each project.

If the 4G signal was sufficient, the target solution for Lords Projects was implemented. A 4G network router has been installed, the receiver has been configured with the network and the system has been checked.

To amplify the 4G signal, a 10-dbi Mikrotik antenna directive has been installed.

If the 4G network signal was insufficient, the satellite antenna has been mounted.

## 4.4. Comparison of costs and speed rates and student observations

Comparing satellite and 4G systems costs we can check at Table 1 that in the case of satellite, the initial cost is 500 € per device, and the monthly fee for a 25 GB quota is 60 €. 4G-based technology costs are really much smaller. The cost of one antenna is 75 €, and monthly fee for an unlimited quota is 25 € per month.

<b>Comparison of costs and speed rates (average of several tests) for 4G and Ka-satellite technologies</b>		
<b>Communications type</b>	<b>4G</b>	<b>Ka-satellite</b>
<b>Initial cost for device</b>	75 €	500 €
<b>Monthly fee</b>	25 €	60 €
<b>Monthly high-speed quota</b>	Unlimited	25 GB
<b>Download rate</b>	25 Mbps	30 Mbps
<b>Upload rate</b>	5 Mbps	3 Mbps
<b>Lag time (Typical value)</b>	20 ms	800 ms

*Image 79: Table with comparison of the cost and speed rates for 4G and Ka-satellite technologies used for monitoring needs for photovoltaic farm in Poland.*

The transmission speed rates for Ka-satellite system are 30 Mbps for downlink and 3 Mbps for uplink (the direction in which the majority of the information is sent, because the solar farm is sending much more information than the one received). For 4G system, the results obtained after running speed tests at the different locations are better for our main purpose (around 5 Mbps for uplink).

In both cases, rates are certainly sufficient to monitor and control solar farms with the sole and important exception of lag time and its negative effects for the real-time remote video analytics controlling, as explained in previous chapters.

## 4.5. Conclusion for Gateway to the Internet.

The 4G networks are exponentially becoming more and more efficient, for which relying on them for monitoring communication systems in rural area locations (as it happens in our case with solar farms) at the expense of Ka satellite systems will be much more usual progressively, also depending on local conditions and the speed and coverage growth of 4G operators. In the case of Poland, the signal has become stronger and more stable, and the connectivity has a larger range, which covers almost the entire country.

In addition, as checked on site from our user's experience, 4G networks are cheaper to install and maintain than satellite systems and their exponential growth is very positive for the effective monitoring of scattered PV generators, a key factor for the distributed production. This is an advantageous option, not only from the cost-saving because of the lower transport losses but also because distributed systems have the potential to supply electricity during grid outages resulting from extreme weather or other emergency situations, reducing blackouts or the adverse effects of terrorism. [11]

However, satellite systems can also work in conjunction with 4G networks, where we can divide the transmitted information for a specific system, e.g. the 4G network can be responsible for the data collected from video cameras, and the satellite system is responsible for other data with no need of interaction, as production control or weather station. Another variant of the solution is to use satellite systems only as backup data, whilst 4G can be mainly used to collect data.

The table below contains the set of parameters for technologies of various networks.

<b>Set of parameters for the different existing technologies of Mobile Wireless Communications</b>			
<b>Kind of technology</b>	<b>Value max. Downlink (1)</b>	<b>Value max. Uplink (1)</b>	<b>Latency (Typical value)</b>
<b>Real needs of PV farm system</b>	128 kbps	10 Mbps	As low as possible for interaction purposes
<b>Satellite</b>	20 Mbps	6 Mbps	600 ms
<b>5G</b>	10-20 Gbps	1-10 Gbps	1 ms
<b>4G+ (LTE-A CAT 16)</b>	700-1000 Mbps	50+ Mbps	20 ms
<b>4G (LTE CAT 4)</b>	150 Mbps	50 Mbps	40 ms
<b>3G (DC-HSPA+)</b>	42.2 Mbps	8 Mbps	100-500 ms
<b>2G (EDGE)</b>	300 kbps	100 kbps	300-1000 ms

*Image 80: Table with comparison of the parameters for different network technologies.  
(1) Lab conditions: Maximum available resources, optimal environment.*

Image 80 [12, 13] does not include information about the future 6th Generation of Mobile Wireless Communications, given that the joint of telecommunications standard development organizations (ARIB, ATIS, CCSA, ETSI, TSDSI, TTA, TTC), to produce the Reports and Specifications from 3G and beyond, also known as 3GPP (3rd Generation Partnership Project) [14] has not defined yet the 6G standard, as well as its specifications, capabilities and timelines.

Comparing the two systems in terms of security, we can conclude that the satellite system is much more secure than 4G networks, because its point-to-point beam makes difficult that other indirect relays could hack or steal private information. Moreover, satellite systems do not introduce a sporadic presence of users with mobile devices that may appear and suddenly consume 4G resources in a certain area.

And of course, a very important advantage from 4G networks is the reduced lag time, enabling an easy remote interaction from a system supervisor, mainly to control video analytics in a dynamic way. In fact, I+D Energías will be also migrating existing Energija installations from satellite to 4G during the following months, precisely because of this reason.

## 5. CONCLUSIONS

Thanks to several months of work at I+D Energias, I was able to learn about the construction process of solar farms in Poland. I had the opportunity to work with wonderful people on various issues related to solar farm. We have introduced optimization of farm monitoring systems, which reduces costs and improves the quality of systems.

For monitoring system in Energias dossier all the inverters are together, attached to the transformer station wall, so first solution: we can make the routing between SCB and inverter in DC, this solution is cheaper, because we use 2 unipolar aluminium cables instead of a multipolar one. The second solution is to use a simple FTP cable to create a modbus connection with no losses risk because there are very few cm between inverter and inverter.

In Lords dossier for monitoring system we use string inverters attached to the structures, so we avoid using SCBs. Moreover, Huawei's string inverters use different working points, so we optimise the system performance because we connect strings with same tilt angle and height for a single working point. Furthermore, we use PLC connection so we avoid the Modbus infrastructure, and we can work with AC cable between inverter and transformer station.

When considering a CCTV system, using video analytics is a useful way to avoid making active video surveillance (classical system) with continuous and periodical direct observation. Just one fibre optics connection is needed to make the link between main cabinet and AC3CON. The rest of the connections are done through FTP cable, cheaper than fiber optics and it also fulfils technical features for our purposes.

Taking in to consideration Internet Gateway, switching from satellite to 4G option is better from lag reduction (especially useful for remote interaction) and also from economical point of view.

Tasks, solutions to problems that have been undertaken in this thesis, experience, skills and knowledge gained are listed in the table with the final conclusions on Image 81.



TASK COMPLETED	ADVANTAGES
String Combiner Boxes have been configured and installed for each solar panel string and connected with the Sungrow inverter. The monitoring box have been connected and optimized.	Knowledge and skills were acquired about the construction and operation of the entire system on a photovoltaic farm. Experience in working on photovoltaic farm projects has been gained.
String Inverters and PLC connection for Lords architecture: Modern Huawei Inverters were introduced. The Programmable Logic Controller (PLC) has been implemented. Special additional protection of cables and connections between them against UV radiation and weather conditions was invented and implemented.	Knowledge was gained about the work of Huawei inverters and the entire system on a solar farm. The solution for Lords Dossier is more expensive, but thanks to the robust solution, it is much more durable and safer, because there are no hand-made fuses.
Implementation and optimization of the Weather Station.	Knowledge and skills were acquired about the construction and operation of a weather station. This allows you to monitor the weather conditions prevailing on the solar farm.
The technical analysis of the inverter productivity, the weather station and the weather forecast, the power obtained by photovoltaic panels, the irradiation for solar farm, the ambient temperature and the panel temperature, the wind speed, was carried out using the SCADA program.	We control all factors and data on an ongoing basis, and by analyzing the data on the charts, we can react immediately if the data is not as expected.
Construction, optimization and run the CCTV system. In these projects 2 concentration points were used, which collect the image from other cameras (by FTP cables) located near these points. However, the combination of these 2 concentration points was made of fiber optic. An infrared lamp was installed to ensure better visibility for the camera at night.	Knowledge and skills were gained about the operation of the CCTV system, connections between cameras, and problems associated with the image of the camera. Thanks to the solution we have used in these projects, we can collect data from cameras without loss of information.
Supervision and monitoring optimization by the EZStation software. Video analytics and FLIR System.	Knowledge and skills were acquired about the cameras' work. It helps supervising and monitoring the operations of cameras on the photovoltaic farm and protect all solar farm.
Global satellite solution: the satellite signal was analysed, the satellite antenna was chosen and mounted.	Knowledge and skills have been acquired about the implementation of satellite connections.
4G network router was installed and installed, the receiver was configured with the network and the system was checked, the Mikrotik antenna was mounted. The 4G network connectivity test was carried out.	Knowledge and skills have been acquired about the implementation of 4G network connections. The 4G signal has increased.

*Image 81: Table with the final conclusion.*

Simultaneously with the process of writing the engineering thesis, a scientific article was created. It is titled 'Positive effects of the migration from Ka-band satellite to 4G solution for the communication needs of a scattered set of 1 MW solar farms in Poland: a user's experience'.

The article is the result of international cooperation of student and scientists from Spain and Poland. The authors of the text are: Witold Bąk, Enrique Tébar PhD, Luis Hurtado, Zbigniew Kulesza M.Sc. Eng. and Prof. Andrzej Napieralski. Their CVs are available at Annex 3.

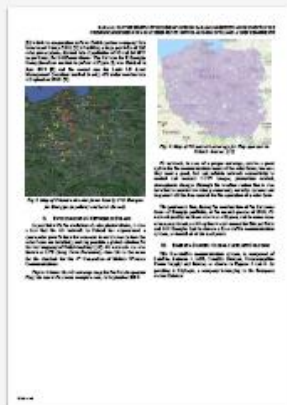
This paper contains a concise overview of the deployment of scattered solar power plants in Poland, mainly from the perspective of their communication networks, and how the recent development of the Polish 4G networks has a very positive impact for the performance of the whole monitoring system (production control and video-surveillance), with a special emphasis on video-analytics, due to its higher bandwidth demand.

The article is already finished and is waiting for publication in INTERNATIONAL JOURNAL OF MICROELECTRONICS AND "COMPUTER SCIENCE".

We can notice synergies between the content of the entire article and thesis, especially in chapter 4 on the gateway to the internet. The global screenshot of the paper is presented on Image 82.



1



2



3



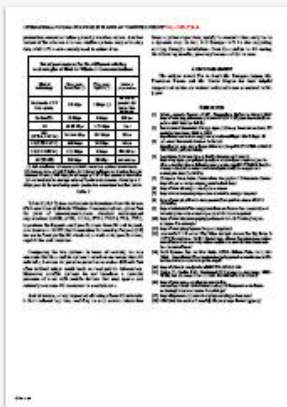
4



5



6



7



8



9

Image 82: Article. [own screenshot]

## 6. BIBLIOGRAPHY

### MOTIVATION

- [1] <https://www.idenergias.com/quienes-somos>
- [2] <https://suninvestmentgroup.com/a-renewable-energy-company/>
- [3] <https://www.pb.pl/litwini-duzo-postawili-na-polskie-slonce-933041>  
(in Polish)
- [4] <https://lordslb.lt/eiffel-energy-transition-to-finance-the-construction-of-66-solar-parks-with-a-total-capacity-of-65-5-mw-in-poland>
- [5] Polska Agencja Prasowa (PAP), Photovoltaic Market in Poland 2019:  
<https://www.pap.pl/centrum-prasowe/471231%2Crynek-fotowoltaiki-w-polsce-2019.html> (in Polish)

### INVERTERS PRODUCTION AND METEO MONITORING

- Huawei Inverter: SmartLogger1000A User Manual
- Sungrow Inverter: TI 20180615 SG125HV User Manual V112

### VIDEO ANALYTICS AND FLIR SYSTEM

- [6] Ainsworth P: 5 Reasons Why Video Analytics is now the Big Focus in CCTV Surveillance, IFSEC Global: <https://www.ifsecglobal.com/video-surveillance/5-reasons-why-video-analytics-is-now-the-dominant-tech-in-cctv-surveillance/>
- [7] FLIR Systems, Inc: ioi User Guide, HTML Edition Units, ver.1, Nov 2016:  
<https://www.flir.com/globalassets/imported-assets/document/flir-ioi-html-edition-units-user-guide-en.pdf>

### GATEWAY SYSTEM

- [8] <https://www.tabletwo.pl/play-podsumowanie-2018-roku-plany-na-nastepne-lata-strategia/>
- [9] <https://www.play.pl/pomoc/mapa-zasiegu.html>
- [10] <https://mikrotik.com/product/RBSXTG-2HnDr2-168>
- [11] Mehto V., Phadke B.N.: Distributed PV Systems an Advantage, IOSR-JEEE, Vol. 12, Issue 2 Ver. II, DOI: 10.9790/1676-1202021419
- [12] <https://www.gsma.com/futurenetworks/wp-content/uploads/2015/01/Understanding-5G-Perspectives-on-future-technological-advancements-in-mobile.pdf>
- [13] <https://5gobservatory.eu/info-deployments/5g-performance/>
- [14] 3GPP (3rd Generation Partnership Project): <https://www.3gpp.org/>

## 7. IMAGES LIST

<i>Image 1: Map of Poland with solar farms built by I+D Energías</i> .....	7
<i>Image 2: Graph of installed power in photovoltaic sources. [5]</i> .....	8
<i>Image 3: Module Connection Detail for Type 1 (68 positions) and Type 2 (36 positions) tables, with 34-panel strings making a C and zig-zag connection respectively. [company source]</i> .....	9
<i>Image 4: LV Single-Line Schema for a PV farm: SCBs 1 and 2 are composed of 16x34-panel strings, SCBs 3 to 6 are composed of 15x34-panel strings and SCB 7 is composed of 15x33-panel strings, so total peak power must be slightly under 1 MW. [company source]</i> .....	10
<i>Image 5: Piaski 1 MW PV farm photo taken with a drone (1). [own photo]</i> .....	10
<i>Image 6: Piaski 1 MW PV farm photo taken with a drone (2). [own photo]</i> .....	11
<i>Image 7: Structure layout of Piaski solar farm.</i> .....	11
<i>Image 8: Scheme of electrical trenches and internal road in Piaski Photovoltaic Farm. [company source]</i> .....	12
<i>Image 9: Trenches scheme for the cabling for one photovoltaic farm:</i> .....	12
<i>Image 10: SCB Details: Trench section, underground cable and supporting frame. [company source]</i> .....	13
<i>Image 11: String Combiner Box mounted over photovoltaic structure. [own source]</i> .....	14
<i>Image 12: SCB Installation for Energija Projects:</i> .....	15
<i>Image 13: SCB Box Single Wire Schema (1). [company source]</i> .....	16
<i>Image 14: SCB Box Single Wire Schema (2). [company source]</i> .....	16
<i>Image 15: Interior of String Combiner Box. [own photo]</i> .....	17
<i>Image 16: String Inverter architecture for Energija dossier.</i> .....	18
<i>Image 17: Sungrow Inverters attached to the Trafo Station's wall. [own photo]</i> .....	18
<i>Image 18: Single line scheme for Energija projects from strings up to the Trafo Station. [company source]</i> .....	19
<i>Image 19: Modbus connection for String Inverters in Energija projects. [company source]</i> .....	19
<i>Image 20: Communication connection for middle (all but the last) modbus inverter.</i> .....	20
<i>Image 21: Communication connection for last modbus inverter. In yellow box,</i> .....	20
<i>Image 22: Components inside a monitoring box: Top shelf: IP Power,</i> .....	22
<i>Image 23: Monitoring System inside the Transformer Station with a laptop connected. [own source]</i> .....	23
<i>Image 24: Monitoring Diagram for Energija projects through the monitoring box. [company source]</i> .....	23
<i>Image 25: General Monitoring Diagram for Energija Projects. [company source]</i> .....	24
<i>Image 26: 9-inverter busbar architecture inside the trafo station. [own source]</i> .....	25
<i>Image 27: PLC connection to the 9-inverter busbar architecture. [own source]</i> .....	26
<i>Image 28: String Inverter architecture for Lords dossier.</i> .....	26
<i>Image 29: Huawei Inverter for Lords project.</i> .....	27
<i>Image 30: Joint of 9 Huawei Inverters on a Lords photovoltaic farm. [own source]</i> .....	27
<i>Image 31: Monitoring Diagram for Lords projects through Huawei's Smartlogger. [company source]</i> .....	28
<i>Image 32: Single Line Schema for Lords projects from strings up to the Trafo Station. [company source]</i> .....	28
<i>Image 33: First section of PLC cable routing between the Busbar and the Huawei Smartlogger device, up to the PLC Fuse System. [own source]</i> .....	29
<i>Image 34: 3-Phase Fuse system for PLC protocol,</i> .....	30
<i>Image 35: PLC Architecture for Huawei inverters. At point (C), from the Busbar connection, power and monitoring signals are split up. Signals are sent to Smartlogger (E). [Huawei manual]</i> .....	30
<i>Image 36: SUN2000 Inverter's bottom connections. [Huawei manual]</i> .....	31
<i>Image 37: Rear view schema of Huawei's Smartlogger. Connection number 13 corresponds to PLC inputs, used in Lords projects. [Huawei manual]</i> .....	31
<i>Image 38: Rear view picture of Huawei's Smartlogger. [own photo]</i> .....	32
<i>Image 39: Table with comparison of inverters' parameter for Energija and Lords dossier.</i> .....	34
<i>Image 40: Opened Meteorological Box with Datalogger and Power Supply. [own photo]</i> .....	36
<i>Image 41: Weather Station composed of: Meteo Box (mounted as close as possible from Trafo Station), Anemometer, Calibrated Cell and Pyranometer. [own photo]</i> .....	37
<i>Image 42: Ambient and Panel Temperature Sensors</i> .....	37
<i>Image 43: Meteo Box connected to Huawei's Smartlogger. [own photo]</i> .....	38
<i>Image 44: Weather Station Layout. [company source]</i> .....	39
<i>Image 45: Scada software screenshot. [own screenshot]</i> .....	40
<i>Image 46: Power plot from Korabiewice photovoltaic farm. [own screenshot]</i> .....	41
<i>Image 47: Weather station and weather forecast for Korabiewice solar farm from Scada software. [own screenshot]</i> .....	41
<i>Image 48: Power obtained by photovoltaic panels. [own screenshot]</i> .....	42
<i>Image 49: Irradiation for solar farm. [own screenshot]</i> .....	42

<i>Image 50: Plot of ambient temperature and panel temperature. [own screenshot]</i> .....	43
<i>Image 51: Plot of the wind speed. [own screenshot]</i> .....	43
<i>Image 52: CCTV layout for photovoltaic farm. [company source]</i> .....	46
<i>Image 53: CCTV cabinet next to a transformer station, at right side of the picture.</i> .....	47
<i>Image 54: CCTV cabinet interior. [own photo]</i> .....	48
<i>Image 55: CCTV detail. Connections for primary node are shown below left</i> .....	48
<i>Image 56: CCTV single line. [company source]</i> .....	49
<i>Image 57: CCTV AC3CON box. [company source]</i> .....	49
<i>Image 58: CCTV AC3CON interior. [own photo]</i> .....	50
<i>Image 59: CCTV AC3CON connection. [company source]</i> .....	50
<i>Image 60: CCTV camera and AC3CON mounted on a pole. We can observe specific IR lamp mounted below the camera to help get better image of the camera during the night. [own photo]</i> .....	51
<i>Image 61: CCTV foundation works. [own photo]</i> .....	52
<i>Image 62: Pole with cabling and a manhole after foundation works. [own photo]</i> .....	52
<i>Image 63: Camera Image for one of the photovoltaic farm. [own screenshot]</i> .....	53
<i>Image 64: List of photovoltaic farm operated by EZStation software. [own screenshot]</i> .....	54
<i>Image 65: Operating window for Nuna GMS. [own screenshot]</i> .....	55
<i>Image 66: View from all cameras installed for the Nuna photovoltaic farm – part1. [own screenshot]</i> .....	55
<i>Image 67: View from all cameras installed for the Nuna photovoltaic farm – part2. [own screenshot]</i> .....	56
<i>Image 68: View from one of cameras for the Nuna photovoltaic farm. [own screenshot]</i> .....	56
<i>Image 69: Flir’s Video analytics System with the changing parameters: Depth, Rules, Responses and Scheduled Actions. [own screenshot]</i> .....	57
<i>Image 70: Screenshot of Analytics Configuring: [own screenshot]</i> .....	59
<i>Image 71: Definition of intrusion area (a) and intruder’s height (b) in Flir’s Video analytics System. Human (red) and Animal detection (green) (c). Vehicle detection (d). Non-intruder (left, green) and Intruder detection (right, red) (e). Non-intruder, walking outside the fence (green) (f). Object movement (gate being swung by the wind) (green) (g). Source: I+D Energias’s proprietary production.</i> .....	60
<i>Image 72: Map of 4G network coverage for Play operator in Poland. Source: [9]</i> .....	62
<i>Image 73: Software screenshot with latency results for satellite [own screenshot]</i> .....	63
<i>Image 74: Satellite Modem and Router already connected to the monitoring cabinet, inside transformer station. [own photo]</i> .....	64
<i>Image 75: Satellite Antenna mounted on the top of the transformer station. [own photo]</i> .....	65
<i>Image 76: Satellite antenna with rack and cabling. [own photo]</i> .....	65
<i>Image 77: Software screenshot with latency results for 4G. [own screenshot]</i> .....	67
<i>Image 78: 10-dBi directive Mikrotik antenna to increase. [own photo]</i> .....	68
<i>Image 79: Table with comparison of the cost and speed rates for 4G and Ka-satellite technologies used for monitoring needs for photovoltaic farm in Poland.</i> .....	69
<i>Image 80: Table with comparison of the parameters for different network technologies.</i> .....	71
<i>Image 81: Table with the final conclusion.</i> .....	73
<i>Image 82: Article. [own screenshot]</i> .....	75

## **8. ANNEX 1: Monitoring Box Datasheets**

# 1.IP Serial Datasheets

## System Specifications

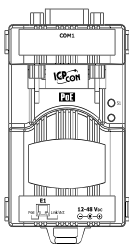
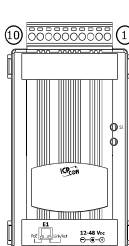
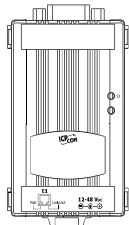
Models	tDS-712 tDS-712i tDSM-712 tDS-2212	tDS-722 tDS-722i	tDS-732 tDS-732i	tDS-715 tDS-715i tDS-2215	tDS-725 tDS-725i tDS-2225	tDS-735 tDS-735i tDS-2235	tDS-718 tDS-718i tDS-2218	tDS-718i-D	tDS-724 tDS-724i	tDS-734 tDS-734i
<b>System</b>										
CPU	32-bit MCU									
<b>Communication Interface</b>										
Ethernet	700 Series	10/100 Base-TX, 8-pin RJ-45 x 1, (Auto-negotiating, Auto-MDI/MDIX, LED indicator)								
	2200 Series	2-Port 10/100 Base-TX Ethernet Switch with LAN Bypass, RJ-45 x 2 (Auto-negotiating, Auto-MDI/MDIX, LED indicator)								
PoE	IEEE 802.3af, Class 1									
COM Port	1 x RS-232	2 x RS-232	3 x RS-232	1 x RS-422/ RS-485	2 x RS-485	3 x RS-485	1 x RS-232 or RS-422/485		1 x RS-485 1 x RS-232	1 x RS-485 2 x RS-232
Self-Tuner	-			Yes, automatic RS-485 direction control						
<b>Power Isolation</b>	<b>1000 Vdc for tDS-722i/ 732i /718i-D only</b>									
<b>Signal Isolation</b>	<b>3000 Vdc for tDS-712i/ 715i/ 725i/ 735i/ 718i /724i /734i only</b>									
ESD Protection	+/-4 kV									
<b>COM Port Capability (16C550 or compatible UART)</b>										
Baud Rate	115200 bps Max.									
Data Bit	5, 6, 7, 8									
Parity	None, Odd, Even, Mark, Space									
Stop Bit	1, 2									
<b>Power</b>										
Power Input	IEEE 802.3af, Class 1 for PoE +12 ~ 48 Vdc for DC Jack									
Power Consumption	0.07 A @ 24 Vdc									
<b>Mechanical</b>										
Connector	700 Series	Male DB-9 x 1	10-pin Removable Terminal Block x 1				Male DB-9 x 1	10-pin Removable Terminal Block x 1		
	2200 Series	5-pin Removable Terminal Block x 3								
Dimensions (W x H x D)	700 Series	52 mm x 95 mm x 27 mm (tDS-712: 52 mm x 90 mm x 27 mm) (tDSM-712: 75 mm x 83 mm x 24 mm)								
	2200 Series	90mm x 110mm x 33mm (without connectors)								
Installation	DIN-Rail mounting									
Case	Metal for tDSM-712; Plastic for others.									
<b>Environment</b>										
Operating Temperature	-25 °C ~ +75 °C									
Storage Temperature	-30 °C ~ +80 °C									
Humidity	10 ~ 90% RH, non-condensing									

2

7

Serial Device Server

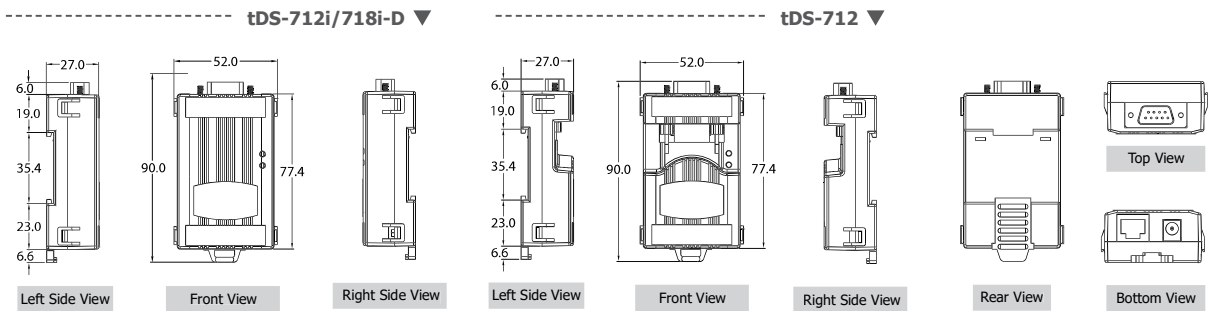
## Pin Assignments

	<b>tDS-712/tDS-712i/tDSM-712</b>				<b>tDS-722/tDS-722i</b>		<b>tDS-732/tDS-732i</b>		<b>tDS-735/tDS-735i</b>		<b>tDS-718/tDS-718i</b>			
	09	N/A			10	F.G.	10	F.G.	10	F.G.	10	F.G.	09	N/A
	08	CTS1			09	CTS2	09	GND	09	GND	09	GND	08	GND
	07	RTS1			08	RTS2	08	RxD3	08	D3-	08	D3-	07	RxD1
	06	N/A			07	RxD2	07	TxD3	07	D3+	07	D3+	06	TxD1
	05	GND			06	TxD2	06	GND	06	GND	06	GND	05	GND
	04	N/A			05	GND	05	RxD2	05	D2-	05	D2-	04	RxD1-
	03	TxD1			04	CTS1	04	TxD2	04	D2+	04	D2+	03	RxD1+
	02	RxD1			03	RTS1	03	GND	03	GND	03	GND	02	TxD1-/D1-
	01	N/A			02	RxD1	02	RxD1	02	D1-	02	D1-	01	TxD1+/D1+
			01	TxD1	01	TxD1	01	D1+	01	D1+				
	<b>tDS-718i-D</b>			<b>tDS-715/tDS-715i</b>		<b>tDS-725/tDS-725i</b>		<b>tDS-724/tDS-724i</b>		<b>tDS-734/tDS-734i</b>				
	Terminal No.	RS-232	RS-422	RS-485	10	F.G.	10	F.G.	10	F.G.	10	F.G.		
	09	N/A	N/A	N/A	09	N/A	09	N/A	09	N/A	09	GND		
	08	CTS	N/A	N/A	08	N/A	08	N/A	08	CTS2	08	RxD3		
	07	RTS	N/A	N/A	07	N/A	07	N/A	07	RTS2	07	TxD3		
	06	N/A	N/A	N/A	06	N/A	06	GND	06	GND	06	GND		
	05	GND	GND	GND	05	GND	05	D2-	05	RxD2	05	RxD2		
	04	N/A	RxD-	N/A	04	RxD1-	04	D2+	04	TxD2	04	TxD2		
	03	TxD	RxD+	N/A	03	RxD1+	03	GND	03	GND	03	GND		
	02	RxD	TxD+	Data+	02	TxD1-/D1-	02	D1-	02	D1-	02	D1-		
01	N/A	TxD-	Data-	01	TxD1+/D1+	01	D1+	01	D1+	01	D1+			

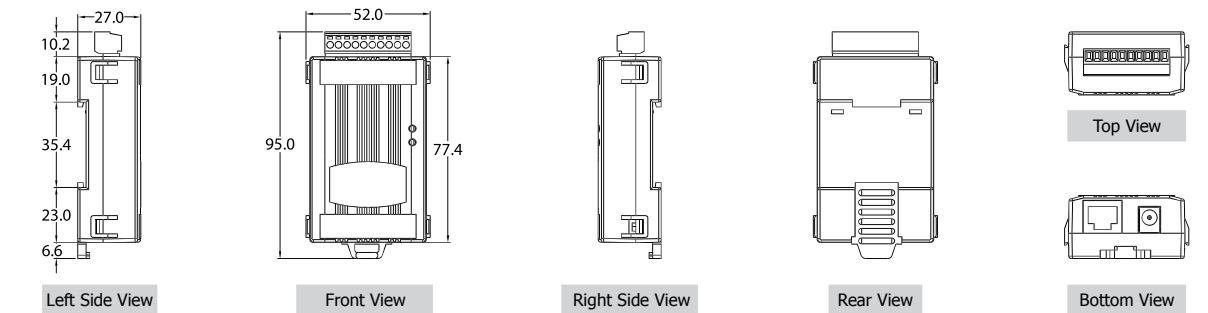


## Dimensions (Unit: mm)

tDS-712/712i/718i-D



tDS-715(i)/718(i)/722(i)/725(i)/732(i)/735(i)/724(i)/734(i)



## Ordering Information

**Note:** ▶ Available soon

Non-Isolated	Isolated	2-port Ethernet Switch	Serial Device Server: Includes one CA-002 cable.
tDS-712 CR	tDS-712i CR	▶tDS-2212	Tiny Device Server with PoE and 1 RS-232 Port (RoHS)
tDS-722 CR	tDS-722i CR	-	Tiny Device Server with PoE and 2 RS-232 Ports (RoHS)
tDS-732 CR	tDS-732i CR	-	Tiny Device Server with PoE and 3 RS-232 Ports (RoHS)
tDS-715 CR	tDS-715i CR	▶tDS-2215	Tiny Device Server with PoE and 1 RS-422/485 Port (RoHS)
tDS-725 CR	tDS-725i CR	▶tDS-2225	Tiny Device Server with PoE and 2 RS-485 Ports (RoHS)
tDS-735 CR	tDS-735i CR	▶tDS-2235	Tiny Device Server with PoE and 3 RS-485 Ports (RoHS)
tDS-718 CR	tDS-718i CR tDS-718i-D CR	▶tDS-2218	Tiny Device Server with PoE and 1 RS-232/422/485 Port (RoHS) (10-pin Terminal Block Connector for tDS-718/718i, Male DB-9 Connector for tDS-718i-D)
tDS-724 CR	tDS-724i CR	-	Tiny Device Server with PoE, 1 RS-485 and 1 RS-232 Ports (RoHS)
tDS-734 CR	tDS-734i CR	-	Tiny Device Server with PoE, 1 RS-485 and 2 RS-232 Ports (RoHS)
tDSM-712 CR	-	-	Tiny Device Server with PoE and 1 RS-232 Port (Metal case, RoHS)

## Accessories

	CA-002	DC connector to 2-wire power cable, 0.3 M
	CA-0915	Male DB-9 to Female DB-9 Cable, 1.5 m
	CA-0910F	Female DB-9 to Female DB-9 Cable, 1.0 m
	CA-0910N	DB-9 Female-Female 3-wire Null Modem Cable, 1M
	CA-PC09F	DB-9 Female Connector with Plastic Cover
	FRA05-S12-SU CR	12V/0.58A (max.) Power Supply (RoHS, for tDS/tGW-700)
	DIN-KA52F CR	24V/1.04A, 25 W Power Supply with DIN-Rail Mounting (RoHS, for NS-205 and NS-205PSE-24V)
	DIN-KA52F-48 CR	48V/0.52A, 25 W Power Supply with DIN-Rail Mounting (RoHS, for NS-205PSE)
	NS-205PSE CR	Unmanaged Ethernet Switch with 4 PoE Ports and 1 RJ-45 Uplink (RoHS)
	NS-205PSE-24V CR	Unmanaged 5-port 10/100 Mbps PoE (PSE) Ethernet Switch; 24 VDC Input (RoHS)

### 3. Technical parameters

**Table 1.** Technical parameters

Parameter	Value
Box size, mm	210 x 85 x 58
Box weight, g	420
Power supply voltage,VDC	12 or 24 (depends on the model) $\pm 2$
Maximum current consumption at 12VDC (when all relays are ON), mA	600
Maximum current consumption at 24VDC (when all relays are ON), mA	400
Operating temperature, °C	0 to 70
Relays maximum switchable current / voltage	10A / 250VAC, 15A / 120VAC, 10A / 28VDC

#### 4. Connectors, ports and led indicators

Bellow is shown a picture with the device connectors, ports and led indicators.

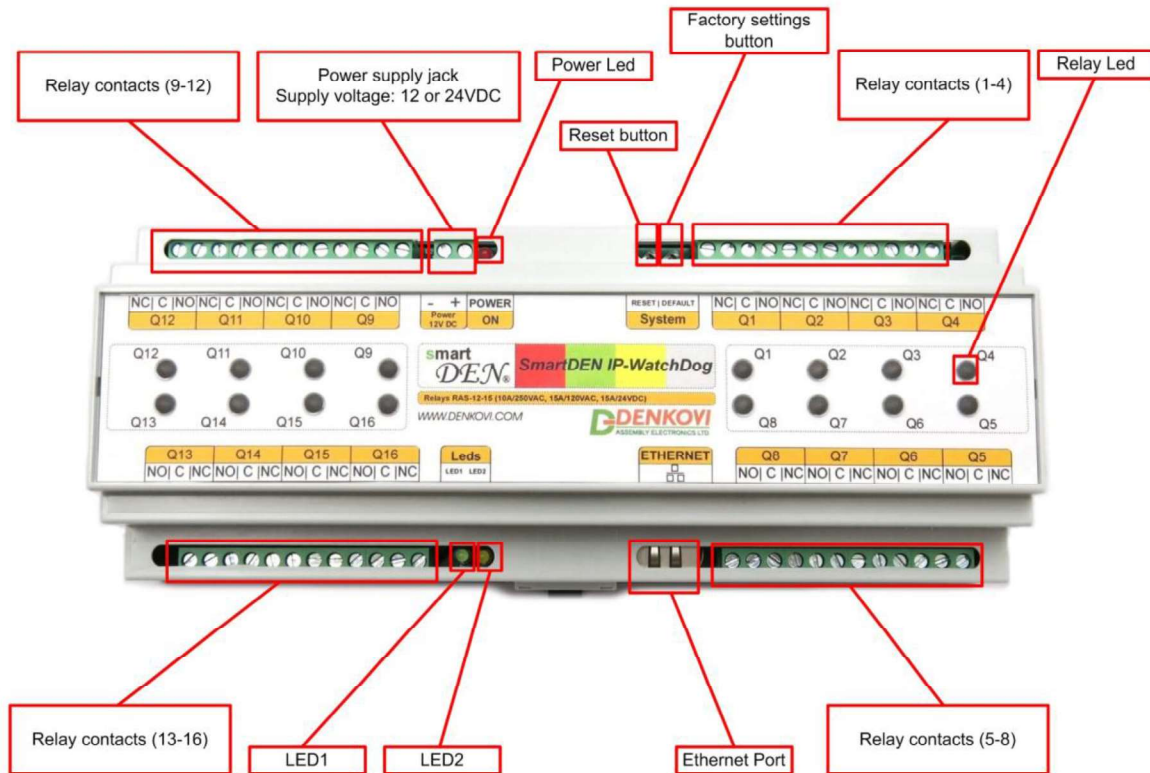


Figure 4. Device overview

#### 5. Installation

- This device must be installed by qualified personnel;
- This device must not be installed directly outdoors;
- Installation consists of mounting the device, connecting to an IP network, connecting the relays, providing power and configuring via a web browser.

## 5.2. Power supply

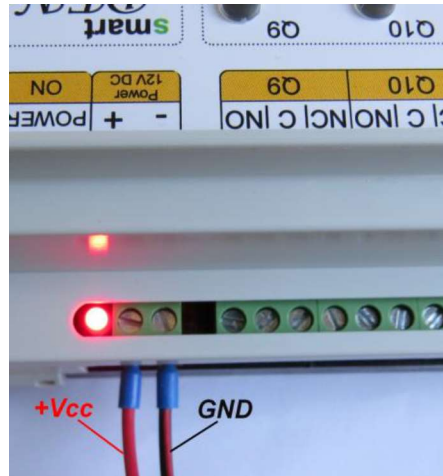


Figure 6. smartDEN IP-WatchDog power supply

Depending on the selected model during purchase the power supply source for **smartDEN IP-WatchDog** must be with voltage either **12VDC** or **24VDC** stabilized and filtered. After power on, the power led must be on and **Led1 indicator** must start blinking in 5 seconds which means the controller is running normally.



Figure 7. Connecting a LAN cable

- ❗ Please keep the polarity and supply voltage range!
- ❗ **smartDEN IP-WatchDog** does not accept AC supply voltage. It is highly recommended to check the power supply source parameters before supply the module.
- ❗ The power supply equipment shall be resistant to short circuit and overload in secondary circuit.
- ❗ When in use, do not place the equipment so that it is difficult to disconnect the device from the power supply.

### 5.3. Connection with the monitored device

smartDEN IP-WatchDog has 16 SPDT relays channels with parameters specified in the technical parameters section. Every relay channel has normally open (NO) and normally closed (NC) contacts connected directly to the terminals. Please refer to Appendix 1 for settings.

#### 5.3.1. In parallel of the device "Reset" button

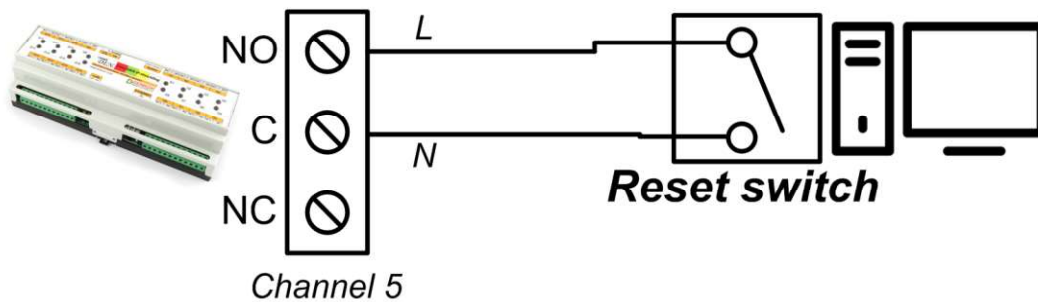


Figure 8. Connection with "Reset" button

#### 5.3.2. In parallel of the device "Power ON/OFF" button

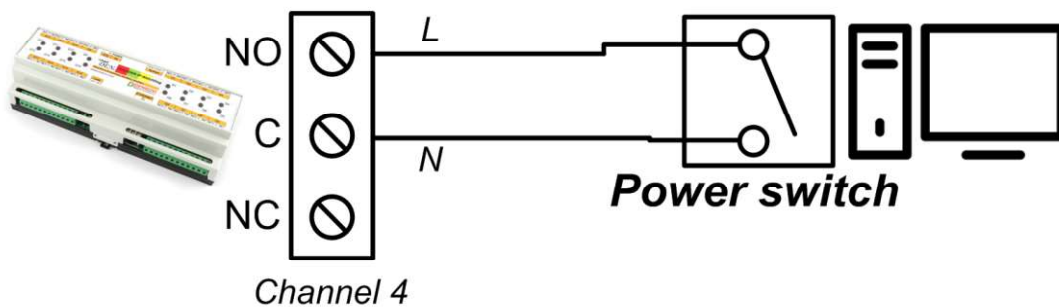


Figure 9. Connection with "Power" button

#### 5.3.3. In sequence of the device power supply cable

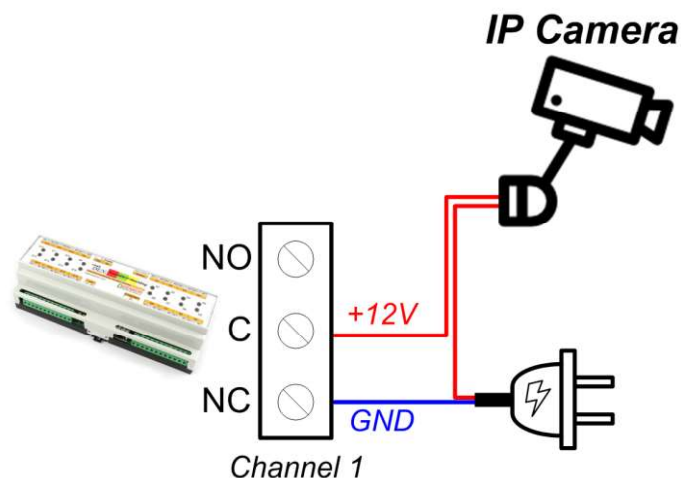
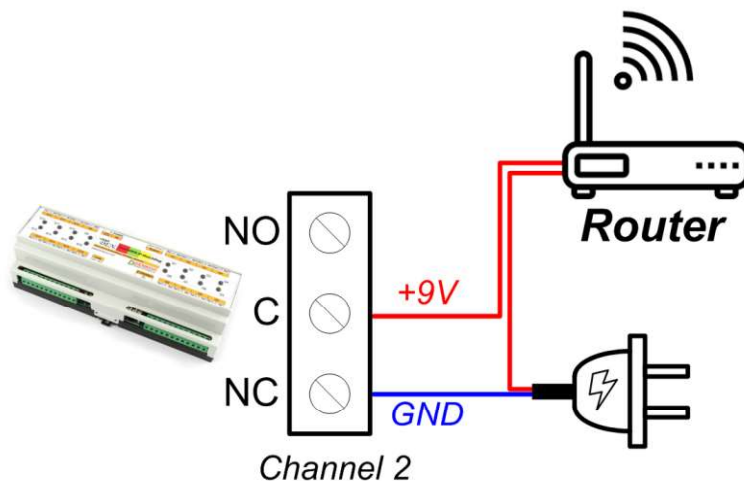
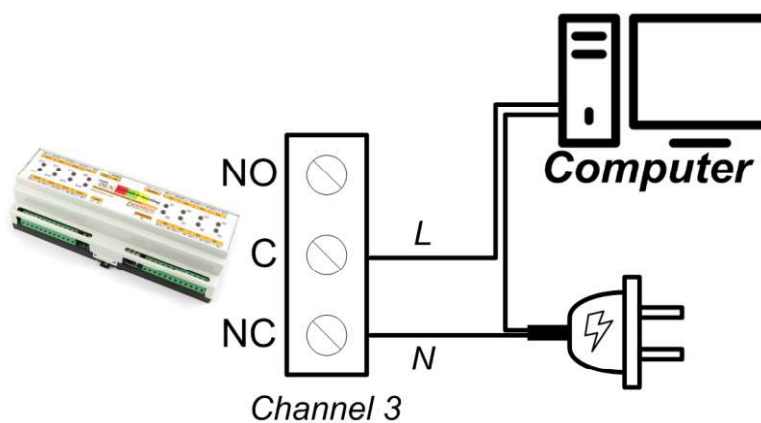


Figure 10. Connection with ip camera power supply



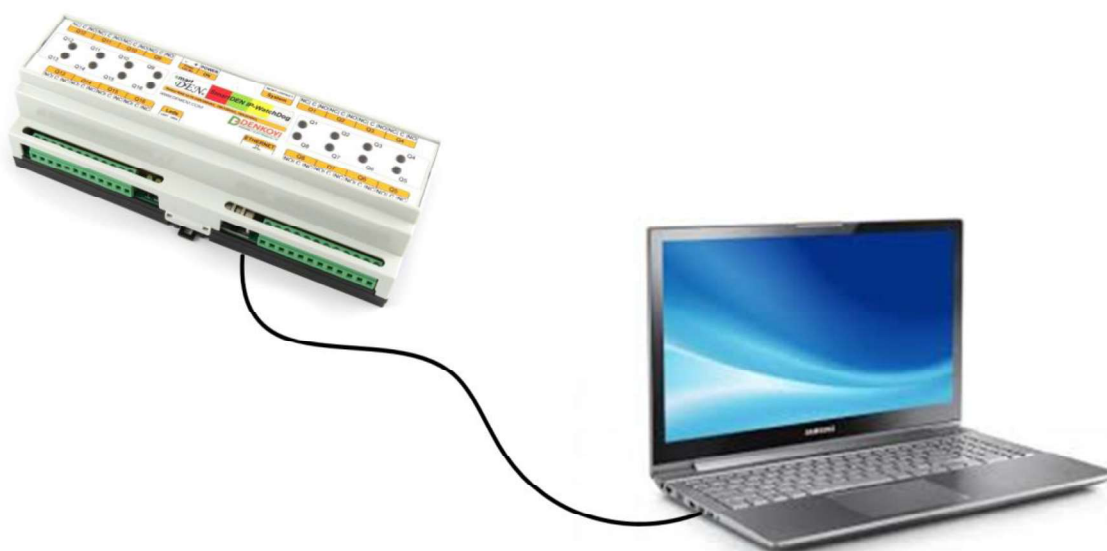
**Figure 11.** Connection with router power supply



**Figure 12.** Connection with computer power supply

#### 5.4. Network connection

smartDEN IP-WatchDog supports AUTO-MDIX so either "crossover" or "straight-through" network cable can be used.



**Figure 13.** Connecting **smartDEN IP-WatchDog** to a computer directly. This is the recommend initial connection.



**Figure 14.** Connecting **smartDEN IP-WatchDog** to a wireless router.

### 3. Router Datasheets



#### Overview

Ubiquiti Networks introduces the EdgeRouter™ X, part of the EdgeMAX® platform. The EdgeRouter X combines carrier-class reliability with excellent price-to-performance value in an ultra-compact form factor.

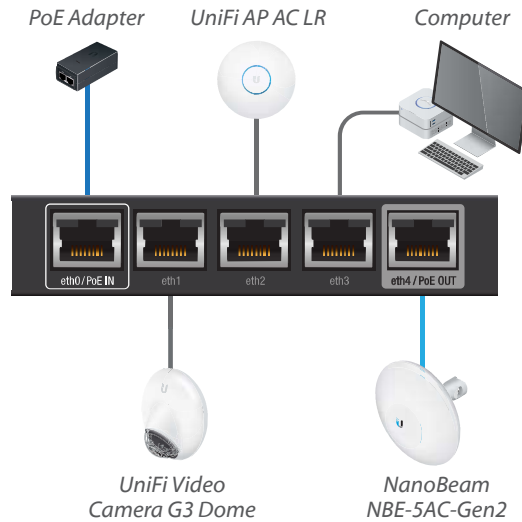
#### PoE Versatility

Two models of the EdgeRouter X are available. The standard model, the ER-X, can be powered by an external power adapter or 24V passive PoE input. A passive PoE passthrough option<sup>1</sup> is available to support a single airMAX® device<sup>2</sup>.

The SFP model, the ER-X-SFP, is powered by an external power adapter. The five Gigabit RJ45 ports support 24V passive PoE output for airMAX or UniFi® devices, while its SFP port provides fiber connectivity to support backhaul applications.

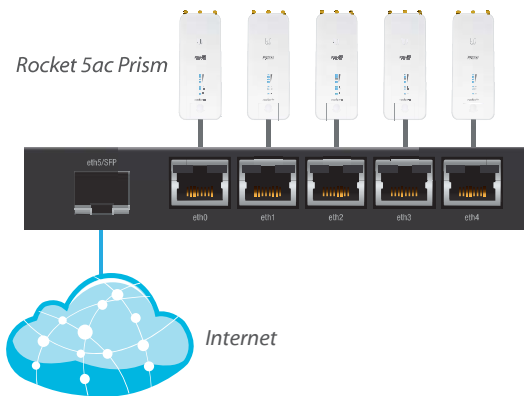
#### Configuration Methods

Powered by a proprietary and intuitive graphical interface, EdgeOS®, every EdgeRouter X can easily be configured for the routing, security, and management features required to efficiently run your network. For advanced network professionals, an integrated CLI is available for quick and direct access using familiar commands.



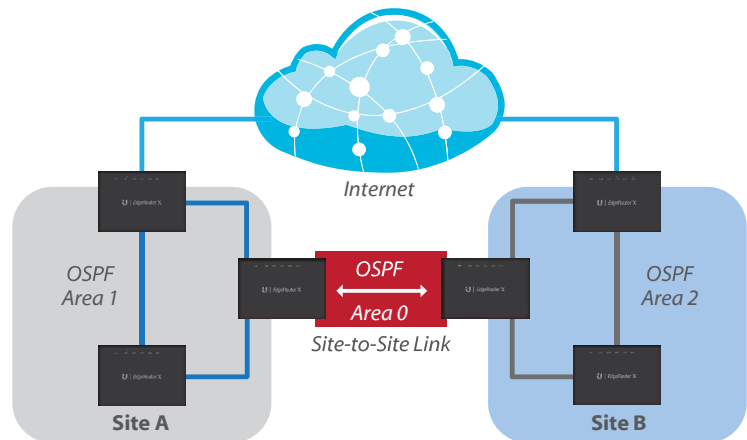
Example of a CPE Deployment for the ER-X

Powered by 24V passive PoE, the ER-X provides data with 24V passive PoE to the NanoBeam® ac and data to the UniFi Video Camera G3 Dome, UniFi AP AC LR, and computer.



Example of a Backhaul Deployment for the ER-X-SFP

Powered by the included 24V power adapter, the ER-X-SFP has a fiber connection to the Internet and provides data with 24V passive PoE to the five Rocket®5ac Prism radios.



Example of a Service Provider Deployment for the ER-X

Multiple ER-X devices connect the Internet and three OSPF areas of the service provider's network.

<sup>1</sup> Requires 24V passive PoE or a 12W minimum power adapter (not included).

<sup>2</sup> Check your airMAX device's specifications for voltage and wattage requirements.





## ICO100-839

Robust DIN-rail Fanless Embedded System with Intel® Celeron® Processor N3350, 2 COM, LAN, 2 USB and DIO

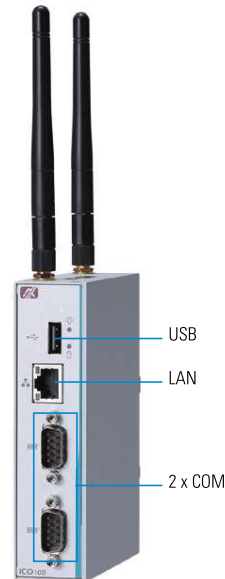
### Features

- Extreme cost-effective with fanless and cableless design
- Intel® Celeron® processor N3350
- 2 COM, 2 USB and GbE LAN
- 8-bit programmable DIO for IoT gateway applications
- Wide operating temperature range from -40°C to +70°C
- 12 to 24 VDC wide range power input
- OVP, UVP, OCP, RPP power protection design
- AXView 2.0 intelligent remote monitoring software for IIoT



### Specifications

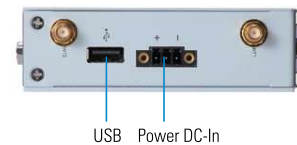
Standard Color	Sliver	
Construction	Extruded aluminum and heavy-duty steel, IP40	
CPU	Intel® Celeron® processor N3350 (1.1 GHz, Dual Core)	
System Board	SBC87839	
System Memory	1 x DDR3L-1866 SO-DIMM, up to 8GB	
BIOS	AMI UEFI BIOS	
System I/O Outlet	Serial	2 x RS-232/422/485 Interface select by BIOS Supports Auto Flow Control in RS-485 mode
	RTC	Battery onboard
	USB	2 x USB 2.0
	Storage	mSATA shared with mPCIe slot (option eMMC flash onboard)
	LAN	1 x 10/100/1000 Mbps Ethernet (Intel® i211-AT for ICO100) (Intel® i210-IT for ICO100-WT) Magnetic isolation protection 1.5KV
	Display	1 x VGA (DB15 connector)
	DIO	1 x DI/DO (8-bit programmable, DB9 female connector) Voltage is 5V TTL-level Programming: I/O sink current is 10mA (max.) Input/output can be programming
	Power Input	1 x DC power input with terminal block



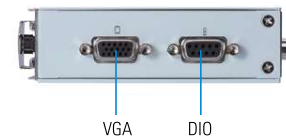
▲ Front view



▲ Rear view



USB Power DC-In



VGA DIO

Extension Interface	1 x Full-size PCI Express Mini Card slot with SIM slot (for wireless module) 1 x Full-size PCI Express Mini Card slot with mSATA (for wireless module or mSATA)
Watchdog Timer	255 levels, 1 to 255 sec.
System Indicator	Power, active
Power Supply	Power Input Range: 12 to 24 VDC, 1.15 to 0.62A (13.80 to 14.88W) Protection: OVP (±20%), reverse protection
Operating Temperature	-20°C to +70°C (-4°F to +158°F) -40°C to +70°C (-40°F to +158°F) (ICO100-WT)
Humidity	10% to 95%
Vibration Endurance	2 Gms (5 to 500Hz, amplitude 0.35 mm; operation/storage/transport)
Weight (net/gross)	0.3 kg (0.67 lb)/0.46 kg (1 lb)
Certifications	CE, FCC Class A
Dimensions	31 mm (1.22") (W) x 100 mm (3.93") (D) x 125 mm (4.92") (H)
EOS Support	Windows® 10 IoT, AXView 2.0 Linux support package(by request)

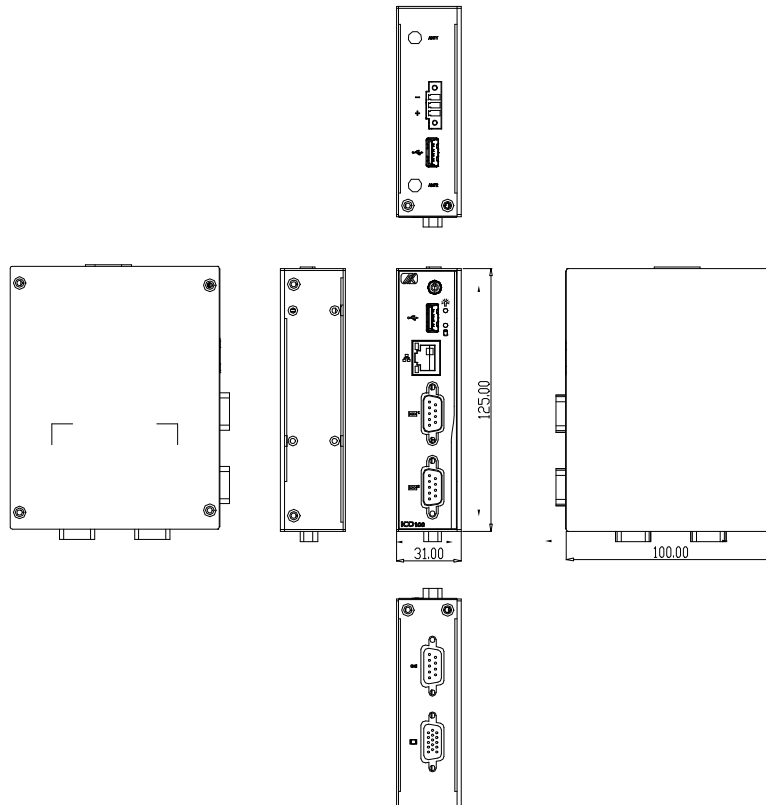
## Ordering Information

Standard	
IC0100-839-N3350-DC (P/N: E22C100104)	Robust DIN-rail fanless embedded system with Intel® Celeron® processor N3350, 2 COM, LAN, 2 USB and DIO (-20°C to +70°C)
IC0100-839-N3350-WT-DC (P/N: E22C100105)	Robust DIN-rail fanless embedded system with Intel® Celeron® processor N3350, 2 COM, LAN, 2 USB and DIO (-40°C to +70°C)

Optional	
mSATA	
8812C1003A0E	IC0100/IC0120 wall mount bracket kit SFP
8816N3234A0E	3G/GPS UC20G kit for tBOX (3G ANT) (E)
8816N3235A0E	3G/GPS UC20G kit for tBOX (3G/GPS ANT) (E)
8812C3003A0E	SparkLAN WPEA-152GN Wi-Fi kit ICO SFP (E)
8812C3004A0E	SparkLAN WPEA-251N Wi-Fi kit ICO SFP (E)
822C3001060E	LTE SIMCOM SIM7100C (TW) for ICO300 SFP

\* Specifications and certifications may vary based on different requirements.

## Dimensions



## **9. ANNEX 2: Meteo Box Datasheets**

## Technical specification

### SYSTEM

CPU	ARM11 700 MHz
RAM	512MB 400MHz
Flash Memory	4096MB EMMC
Operating system	Linux 3.19 or higher
Real Time Clock	RTC, 240 byte SRAM, Watch Dog Timer

### ETHERNET INTERFACE

1x Ethernet 10/100 Mbps (RJ45 connector)

### SERIAL PORTS

RS-232 / RS-485 Ports      2x RS-232 (3 pin) / 2x RS-485 (2 pin) high speed + optoisolation 2.5kV

### USB PORTS

1x external USB 2.0 (host)

### WEJŚCIA / WYJŚCIA

Digital inputs (DI)	4x DI (VIL 0..1 VDC, VIH 2.05..30 VDC) + optoisolation 2.5kV
Digital outputs (DO)	4x DO (0..30V), max. power efficiency: 500 mA + optoisolation 2.5kV
Analog inputs	2x AI - range 0..10V DC (18bit resolution) + optoisolation 2.5kV
1-Wire	1x 1-Wire 5VDC + optoisolation 2.5kV
mBus	1x mBus Master, max. 3 SLAVE devices + optoisolation 2.5kV or 1x RS-232

### POWER SUPPLY

10 ~ 30 V DC, 1000 mA + 6V DC battery

### PARAMETRY MECHANICZNE

Dimensions	127 x 75 x 91 mm
Weight	300g
Casing	Aluminium, DIN bus instalation

### OPERATING AND STORAGE CONDITIONS

0 ~ 70°C, humidity: 5 ~ 95% RH (no condensation)  
 Extended operating temperature: -25 ~ 80°C, humidity 5 ~ 95% RH (no condensation)\*

### AVAILABLE EXPANSION CARDS/MODULES

Wi-Fi (IEEE 802.11 b/g/n, speed up to 150 Mbps, 64/128-bit WEP, WPA, and WPA2)  
 3G/LTE modem, GPS module, Bluetooth, **I/O Module:**  
 8x digital input (DI) or 8x digital output (DO), 4x relay output (RO)

### CONNECTORS AND PHYSICAL INTERFACES

1x RJ45 (Ethernet)  
 2x monostable switch button  
 2x16 pin screw terminal  
 1x USB 2.0 typ A  
 1x2 pin power supply  
 1x2 pin battery  
 1x SIM card slot

### PRODUCER

TECHBASE Group Sp. z o.o., ul. Pana Tadeusza 14, 80-123 Gdańsk

\*some of the expansion cards can limit operating temperature range

## X500 models comparison

HARDWARE	NPE X500	NPE X500 PLUS
Configurable DIO	4	-
Analog Inputs	4	2
CAN	✓	-
mBus Master/RS-232	-	✓
ZigBee	✓*	-
HDMI	✓	-
Internal USB	✓	-
<b>Power supply</b>	DC	DC/battery

\* option

## Accessories

### POWER FEEDERS



#### SDK-0302-12VDC-R

AC/DC power feeder, input 100-240V AC, output 12V DC 1000mA, cable endings in tube terminals



#### DN-20-24

DIN bus power feeder, output 24V DC 24W, input 88..264 V AC or 124..370 V DC

### ANTENNAS



#### ANT-GSM-1M

GSM antenna with frequency 824-960MHz/1710-1910MHz/1920-2170MHz



#### ADA-0086-L

Screw-in angular antenna, SMA, 900/1800 MHz

### 1-WIRE SENSORS



#### 1Wire-Therm-Stainless

Digital temperature sensor in steel housing



#### 1Wire-Therm-ABS

Digital temperature sensor closed in ABS plastic housing

### M-BUS CONVERTERS



#### mBus 10

The mBus 10 is a transparent converter from RS-232 to M-Bus interface.



#### mBus 400

The mBus 400 is a transparent converter from RS-232 to M-Bus interface. You can connect 4 RS-232 signal lines - RxD, TxD, CTS, RTS.

## Pinout

mBus			COM4		COM3		COM2		SGND	COM1		ADC		
M-	M+	MGND	B	A	B	A	TxD	RxT		TxD	RxT	AGND	AI1	AI2

1-Wire			4xD0						4xDI						
1-Wire	+5V0	AGND	AGND	CD+	D01	D02	D03	D04	AGND	AGND	DI1	DI2	DI3	DI4	AGND

TERMINAL 1

RESET  
BUTTON

POWER  
V- V+

AKU  
V- V+

USB

LAN1  
(eth0)

SIM CARD

USER  
BUTTON

## 2. Anemometer datasheets.

### APPLICATIONS

ANEM04403 V3 have been designed to be used in industrial applications: cranes, solar panels, buildings, wind turbines, weather stations...

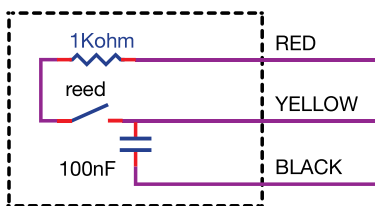
It is usually connected to speed sensors such as tachometers ( see references WM44-EVO, WM44-P V3, WM44-DRM V3), PLCs or data loggers to display the wind speed and/or set alarms to predefined values or to obtain records during predefined periods of time.

### OPERATION

#### Outputs/Inputs

#### Up to 180 km/h of wind speed

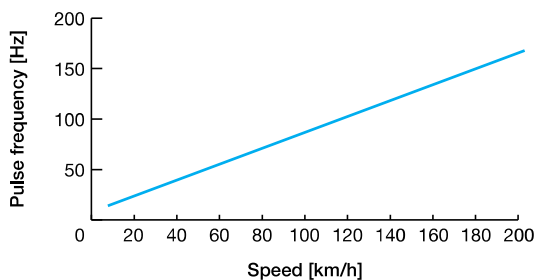
**Output:** Dry reed contact, with a series resistance which switches with a frequency proportional to the wind speed (see graphic). It includes an internal capacitor that can be used as a signal filter.



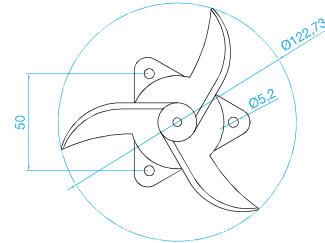
### WIND SPEED / OUTPUT RATIO

The wind speed is given by the function:

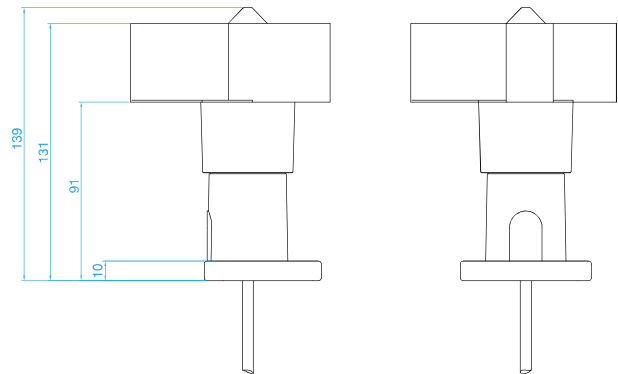
$$\text{Speed (km/h)} = 0.8 * \text{Hz} + 3$$



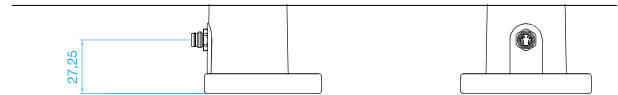
### DIMENSIONS



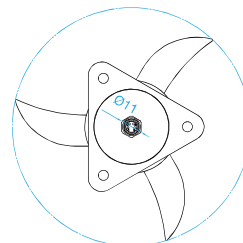
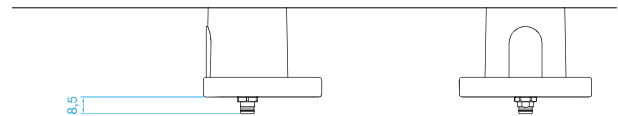
#### ANEM04403 V3 CABLE



#### ANEM04403 V3 M8 LATERAL



#### ANEM04403 V3 M8 UNDERSIDE



## TECHNICAL SPECIFICATIONS

### Electrical features

Power supply	3...24 Vdc
Maximum current	15 mA
Output	Frequency (pulses)
Type of contact	reed

### Measurements

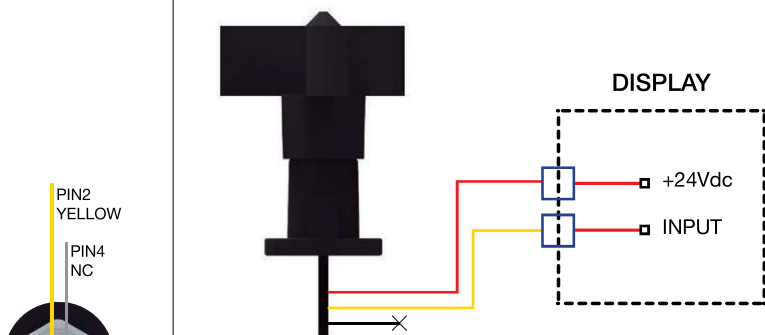
Range	3-180 km/h
Starting speed	8 km/h
Survival speed	200 km/h
Accuracy	1 km/h (3-15 km/h) 3% (15-180 km/h)
Speed-Hz ratio	Speed (km/h) = 0.8*Hz +3

### General features

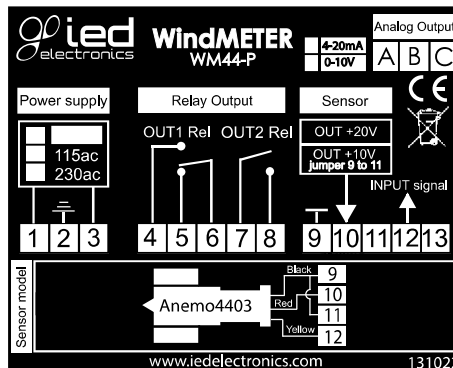
Material	PA + FG
Bearings	Stainless steel X65Cr13
Type of connection	See references (back cover)
Weight (with a 20m cable)	1420 g
Weight (without cable)	130 g
Dimensions	125x139 mm
Storage temperature	-35 °C +80 °C
Working temperature without ice	-20 °C +80 °C
EMC	EN 61000-6-2:2001 EN 55022:2001, Class B
Protection	IP65 (UNE 20324:1993)

## CONNECTION EXAMPLES

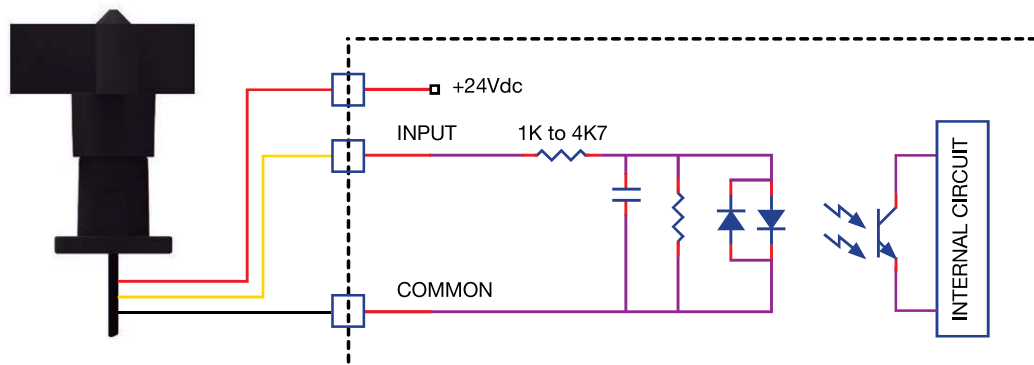
### 2-wire connection to a display



### 3-wire connection to WM44-P V3 display



### 3-wire connection to a PLC





### 3. Calibrated cells.

## Spektron irradiation sensors

The Spektron 210 and 320 are silicon sensors used for measuring the solar irradiation. The Spektron 210 provides a voltage proportionally to the intensity of the solar irradiation. The Spektron 320 has an integrated amplifier. Therefore the sensor signal is amplified and output as a norm signal. The output signal ranges from 0 to 10 V, 0 to 3.125 V, 0 to 150 mV, and 4 to 20 mA at 0 to 1500 W/m<sup>2</sup>.

#### Range of application

- Output and operational check of thermal and photovoltaic solar plants
- Controlling of shading equipment on buildings

- Instruction and training
- Sensor for control systems

#### Ease of use

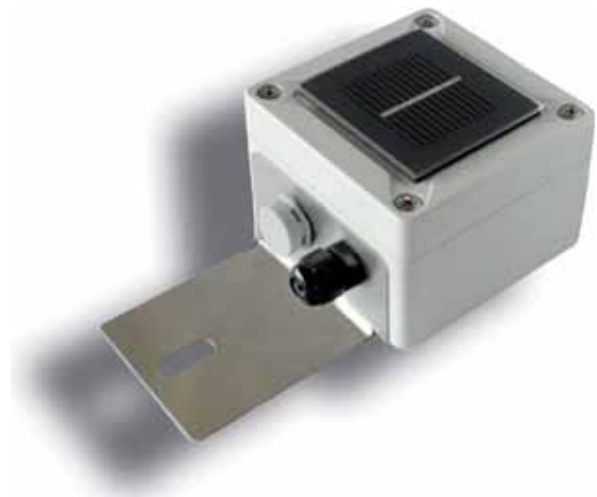
The Spektron can be connected directly to a voltmeter or a datalogger. The voltage measured by the Spektron 210 can be converted into the unit of irradiation (W/m<sup>2</sup>), using the calibration value imprinted on the sensor.

#### Robust casing

The Spektron can be used irrespective of the weather conditions and under any angle of inclination.



Spektron 210: The 2-core extension cable is UV-resistant. All Spektron devices are calibrated beneath a sun light simulator against a reference sensor, which has been calibrated by the Fraunhofer ISE.



The Spektron 320 can output up to four different norm signals, due to its integrated circuit board. This board has to be powered with 5 to 30 V DC or 12 to 30 V DC.

CONTROL AND MEASURING INSTRUMENTS Sensors

Art. No. 0802183 0802259



Model	Spektron 210	Spektron 320
Measuring range	0 - 1500 W/m <sup>2</sup>	0 - 1500 W/m <sup>2</sup>
Sensor type	Monocrystalline cell (13 mm / 33 mm)	Monocrystalline cell (33 mm / 40 mm)
Sensor accuracy	±5 % annual mean	±5 % annual mean
Outlet	Approx. 75 mV at 1000 W/m <sup>2</sup>	4 - 20 mA or 0 - 10 V or 0 - 3.125 V or 0 - 150 mV
Calibration	Sun Simulator Solar Constant 1200 with reference sensor calibrated by the ISE	Sun Simulator Solar Constant 1200 with reference sensor calibrated by the ISE
Design of the sensor	Measuring cell laminated in novafalon and EH foil	Measuring cell enclosed in glass
Supply voltage	-	5 - 30 V DC (at output signal ranges 0 - 3.125 V, 0 - 150 mV, 4 - 20 mA) or 12 - 30 V DC (at output signal ranges 0 - 10 V, 0 - 3.125 V, 0 - 150 mV, 4 - 20 mA)
Power consumption	-	Approx. 30 mW
Casing	Z-profiled aluminium plate, connection encapsulated	Polycarbonate, UV-resistant, with PG screw joint and pressure differential valve
Protection mode	IP65	IP65
Connection	Cable 3 m, 2 x 1.0 mm <sup>2</sup>	Connection terminals, 1.5 mm <sup>2</sup>
Mounting	6 mm drill hole to be fixed with screws	Mounting with drill hole to be fixed with a screw
Dimensions (L / W / H)	118 mm / 50 mm / 44 mm	150 mm / 80 mm / 60 mm
Weight	250 g (incl. cable)	300 g
Warranty	2 years	2 years
Norms	CE mark	CE mark



# The SMP10 Pyranometer

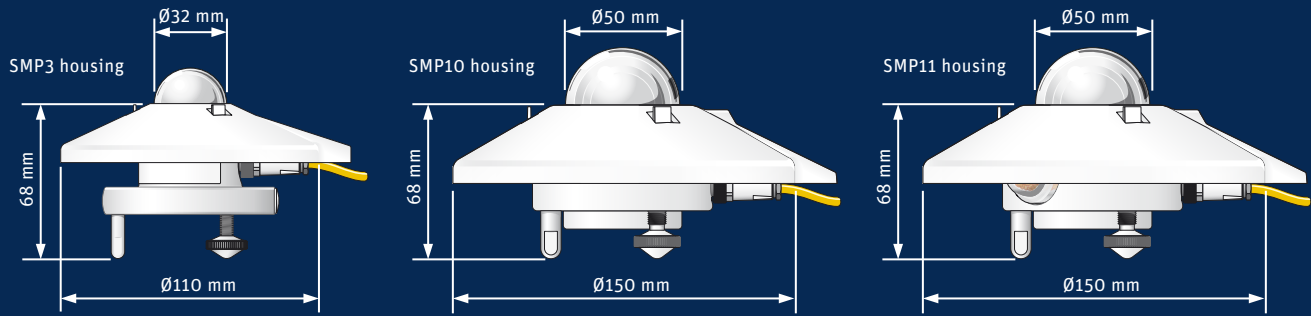
the smartest way to measure solar radiation



**ISO 9060 Secondary Standard pyranometer**  
**No change of desiccant for 10 years**  
**Smart, more than just digital**  
**RS-485 Modbus® communication**

A perfect combination of two of our recent successful launches combined in one instrument; a low maintenance pyranometer with smart digital signal processing. Now with all-new Smart Sensor Explorer software that allows for set-up with RS-485 to USB or TCP/IP converters and data logging to a computer.

[www.kippzonen.com](http://www.kippzonen.com)



Specifications	SMP3	SMP10 & SMP11
Classification to ISO 9060:1990	Second Class	Secondary Standard
Spectral range (50% points)	300 to 2800 nm	285 to 2800 nm
Analogue output • V-version	0 to 1 V	0 to 1 V
Analogue output range	-200 to 2000 W/m <sup>2</sup>	-200 to 2000 W/m <sup>2</sup>
Analogue output • A-version	4 to 20 mA	4 to 20 mA
Analogue output range	0 to 1600 W/m <sup>2</sup>	0 to 1600 W/m <sup>2</sup>
Serial output	RS-485 Modbus®	RS-485 Modbus®
Serial output range	-400 to 2000 W/m <sup>2</sup>	-400 to 4000 W/m <sup>2</sup>
Response time (63%)	< 1.5 s	< 0.7 s
Response time (95%)	< 12 s	< 2 s
Zero offsets		
(a) thermal radiation (at 200 W/m <sup>2</sup> )	< 15 W/m <sup>2</sup>	< 7 W/m <sup>2</sup>
(b) temperature change (5 K/h)	< 5 W/m <sup>2</sup>	< 2 W/m <sup>2</sup>
Non-stability (change/year)	< 1%	< 0.5%
Non-linearity (100 to 1000 W/m <sup>2</sup> )	< 1.5%	< 0.2%
Directional response (up to 80° with 1000 W/m <sup>2</sup> beam)	< 20 W/m <sup>2</sup>	< 10 W/m <sup>2</sup>
Spectral selectivity (350 to 1500 nm)	< 3%	< 3%
Temperature response	< 3% (-20°C to +50°C) < 5% (-40°C to +70°C)	< 1% (-20°C to +50°C) < 2% (-40°C to +70°C)
Tilt response (0° to 90° at 1000 W/m <sup>2</sup> )	< 1%	< 0.2%
Field of view	180°	180°
Accuracy of bubble level	< 0.2°	< 0.1°
Supply voltage	5 to 30 VDC	5 to 30 VDC
Power consumption (at 12 VDC)	-V version: 55 mW -A version: 100 mW	-V version: 55 mW -A version: 100 mW
Detector type	Thermopile	Thermopile
Software, Windows™	Smart Sensor Explorer Software, for configuration, test and data logging	Smart Sensor Explorer Software, for configuration, test and data logging
Operating temperature range	-40°C to +80°C	-40°C to +80°C
Storage temperature range	-40°C to +80°C	-40°C to +80°C
Humidity range	0 to 100% non-condensing	0 to 100% non-condensing
Ingress Protection (IP) rating	67	67
Recommended applications	Economical solution for efficiency and maintenance monitoring of PV power installations, routine measurements in weather stations, agriculture, horticulture and hydrology	High performance for PV panel and thermal collector testing, solar energy research, solar prospecting, materials testing, advanced meteorology and climate networks

Note: The performance specifications quoted are worst-case and/or maximum values



Go to [www.kippzonen.com](http://www.kippzonen.com) for your local distributor

## HEAD OFFICE

**Kipp & Zonen B.V.**  
 Delftechpark 36, 2628 XH Delft  
 P.O. Box 507, 2600 AM Delft  
 The Netherlands  
 +31 (0) 15 2755 210  
 info@kippzonen.com  
 www.kippzonen.com

Kipp & Zonen B.V. reserve the right to alter specifications of the equipment described in this documentation without prior notice

SMP10-V1410

## 5. Temperature Sensor

### TRITEC temperature sensors

#### TRITEC surface temperature sensor Pt1000

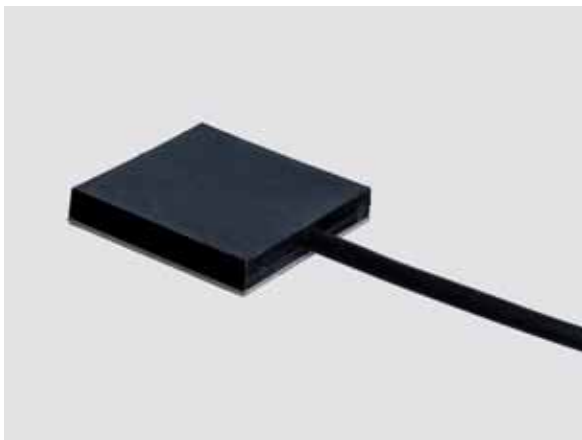
The surface temperature sensor Pt1000 is an adhesive foil sensor. It was designed for measurements on surfaces and is primarily used for temperature measurements of solar modules.

By installing the surface temperature sensor at the back of a solar module, the module temperature can be measured. The temperature of solar modules is crucial for their output, because the output decreases

by 0.43 %/K with increasing temperature. By monitoring the temperature at the solar cells, conclusions can be drawn about the behaviour of the output curve.

#### TRITEC outside temperature sensor Pt1000

The outside temperature sensor Pt1000 is integrated in a weather-proof macrolone housing. Its compact design makes the sensor extremely flexible: it can be installed anywhere. The UV-resistant plastic housing is equipped with a two-core connection cable.



TRITEC surface temperature sensor Pt1000



TRITEC outside temperature sensor Pt1000

CONTROL AND MEASURING INSTRUMENTS Sensors

Art. No. 0802118 0802258



Model	TRITEC surface temperature sensor Pt1000	TRITEC outside temperature sensor Pt1000
Measuring principle	Platinum resistance wire	Platinum resistance wire
Measuring range	-20 to +150 °C	-20 to +150 °C
Protection mode	IP66	IP56
Connection	Cable, 3 m, two-conductor connection	Cable, 3 m, two-conductor connection
Dimensions (W / H / D)	50 mm / 50 mm / 8 mm	52 mm / 50 mm / 32 mm
Casing	Injection moulded plastic with aluminium plate, incl. adhesive tape	Macrolone housing
Weight	120 g	120 g
Warranty	2 years	2 years

## 10. ANNEX 3: Authors of the paper



**Witold Bak** is studying Telecommunications and Computer Science at the International Faculty of Engineering at the Lodz University of Technology. He took part in the International Exchange of Students at the University of Alicante in 2019. In 2019, as part of practices, he started working for the international company I+D Energias dealing with the construction of solar farms in several European countries.



**Enrique Tébar** obtained his MS degree in Telecommunication Engineering in 2002 at the Polytechnic University of Valencia (Spain). Since 2009 he has worked as Solar Energy Consultant and Project Engineer, specialised in International Management. He is also Associate Professor at the Department of Physics, System Engineering and Signal Theory of the University of Alicante (Spain), where he obtained a Ph.D. degree in 2017, based on System

Dimensioning and Control for a Photovoltaic System to recharge an Electric Vehicle and additional programmable loads. At present, he is working as Construction Site Manager for Energija and Lords portfolios in Poland, composed of 109 scattered solar farms of 1 MW each. The whole projects set is a huge distributed PV generator, with independent control systems that need common and fast solutions to counteract the global scene variations that modify the video-analytics for the joint installation.



**Luis Hurtado** obtained his degree in 2011 in Telecommunication Engineering (Specs. in both Image and Sound, and Telematics), and a Master's Degree in Projects Direction and Management.

Since then he has worked in Mobile Communication companies: first as external consultant for Ericsson (PS/IP Service Engineer) and afterwards as Service Engineer in Huawei Technologies Spain. At present, he is working as Specialist Solution Architect in Vodafone Spain,

mainly aimed at design and architecture for projects related with technologies such as mobility and mobile network communications, Internet of Things, Smart Cities, Mission critical communications, Mobile private networks, Wi-Fi in transport vehicles and Massive messaging.



**Zbigniew Kulesza**, MSc. electronics, 1997, TUL Łódź; MSc. psychology, 1991, CUL Lublin; Discipline: Electronics; Specialization: Electronic microprocessor and reprogrammable systems in industrial and embedded applications. Fields of professional activity: design of microprocessor systems: microcontrollers, application processors, embedded systems, embedded real-time operating systems; design of on chip and

reconfigurable systems, HDL languages in the design of integrated circuits; industrial systems and networks design, data visualization and processing, industrial computers and controllers, industrial networks, control and data processing systems in industrial electronics, computer design of electronic circuits. Selected achievements, internships, other: Gold medal with distinction for the invention "Holter recorder with interchangeable Flash memory", 57th World Exhibition of Innovation, Research and Modern Technology - "Brussels Eureka Contest 2008"; Gold medal for the invention of "Low-noise Holter Recorder with Embedded Cardiogram Analysis", 2008 Seoul International Invention Fair, Seoul (2008); Gold medal for "Virtual Glove", International Salon of Ideas - Innovations - New Products - IENA 2009, Nuremberg (2009); Distinction "Łódź Eureka" for "Development of a vibration monitoring system for large rotor machines" (2003)



**Andrzej NAPIERALSKI** received the M.Sc. and Ph.D. degrees from the Technical University of Lodz (TUL) in 1973 and 1977, respectively, and a D.Sc. degree in electronics from the Warsaw University of Technology (Poland) and in microelectronics from the Université de Paul Sabatier (France) in 1989. Since 1996 he has been the Head of the Department of Microelectronics and Computer Science. In 2002 he has been

elected and in 2005 re-elected as the Vice-President of TUL. In 1995 he received the title of Professor, and become the Tenured Professor in 1999.

He is an author or co-author of over 1150 publications and editor of 26 conference proceedings and 13 scientific Journals. He supervised 56 Ph.D. theses; six of them received the price of the Prime Minister of Poland. He is a member of many Scientific Committees of National and International Conferences, and for the last 26 years he has been the General Chairman of Scientific and Organizing Committee of the International Conference „Mixed Design of Integrated Circuits and Systems” – MIXDES. He is the member of the Electronic and Telecommunication Committee of the Polish Academy of Sciences and the Chairmen of Microelectronics Section of this Committee. He is a Senior Member of IEEE. From 2000 until 2009 he was appointment the Chair of IEEE Poland Electron Devices Chapter and from 2001 until 2009 as the Editor of IEEE EDS Newsletter for Scandinavia and Central Europe. In 2012 he was elected the Chairman of Commission Electronics and Photonics of URSI and has been nominated to serve as an EDS Region 8 SRC vice-Chair (2013-2015). In 2008 he received the Degree of Honorary Doctor of Yaroslavl the Wise Novgorod State University (Russia). In 2017, by order of the President of the Republic of Poland, he received the Commander's Cross of the Order of Polonia Restituta